



Fast, Effective Impact Cleaning

Toftejorg TZ-74 Self Cleaning Version Rotary Jet Head

Application

The Toftejorg TZ-74 Self Cleaning Version rotary jet head provides 3D indexed impact cleaning over a defined time period. It is automatic and represents a guaranteed means of achieving quality assurance in tank cleaning. The device is suitable for processing, storage and transportation tanks and vessels between 50 and 500 m³. Used in breweries, food and dairy processes and many other industries with a strict demand for self cleaning of the machine and the downpipe. The Toftejorg TZ-74 Self Cleaning Version rotary jet head has been particularly successful in the brewing industry worldwide.

Working principle

The flow of the cleaning fluid makes the nozzles perform a geared rotation around the vertical and horizontal axes. In the first cycle, the nozzles lay out a coarse pattern on the tank surface. The subsequent cycles gradually make the pattern more dense, until a full pattern is reached after 8 cycles.



TECHNICAL DATA

Lubricant: Self-lubricating with the cleaning fluid
 Standard Surface finish: Ra 0.5µm exterior
 Max throw length: 7 - 15 m
 Impact throw length: 4 - 9 m

Pressure

Working pressure: 3 - 12 bar
 Recommended pressure: 5 - 6.5 bar

Cleaning Pattern

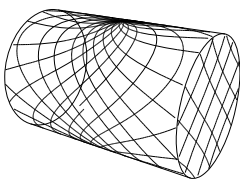

First cycle

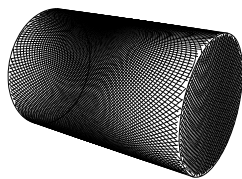

Full pattern

The above drawings show the cleaning pattern achieved on a cylindrical horizontal vessel. The difference between the first cycle and the full pattern represents the number of additional cycles available to increase the density of the cleaning.

Certificates

2.1 material certificate and ATEX.

PHYSICAL DATA

Materials

316L (UNS S31603), PTFE, PEEK, ETFE, TFM

Temperature

Max. working temperature: 95°C
 Max. ambient temperature: 140°C

Weight:

. 6.1 kg

Connections

Standard female thread: 1 ½" Rp (BSP) or NPT, 2" NPT

Caution

Do not use for gas evacuation or air dispersion.



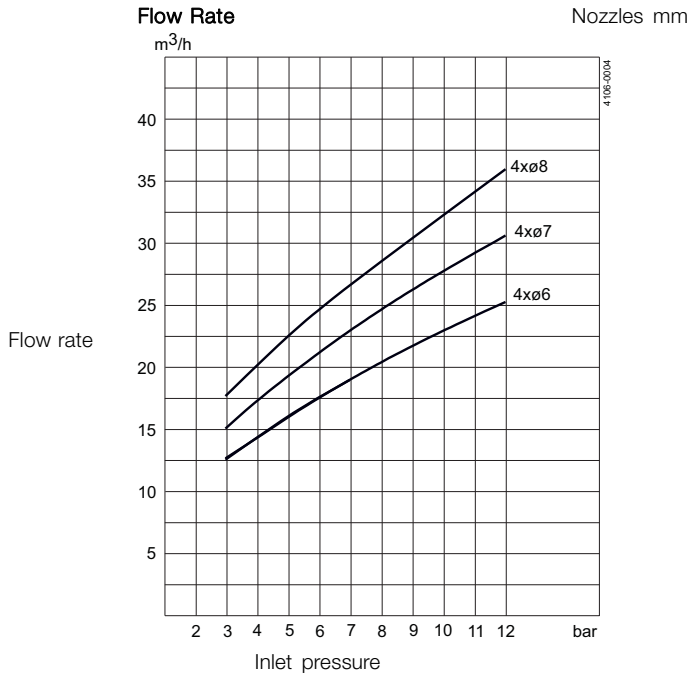

Dimensions (mm)

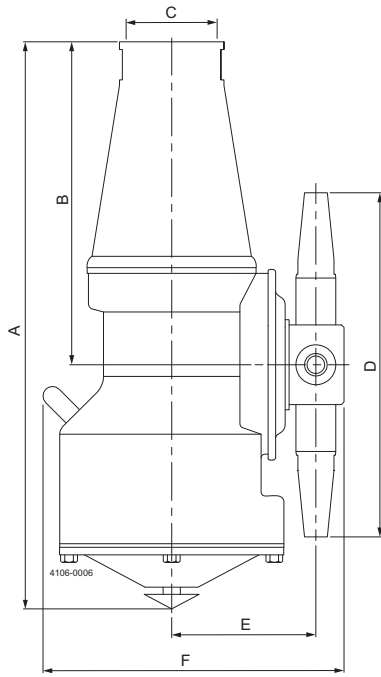

Cleaning Time, Complete Pattern

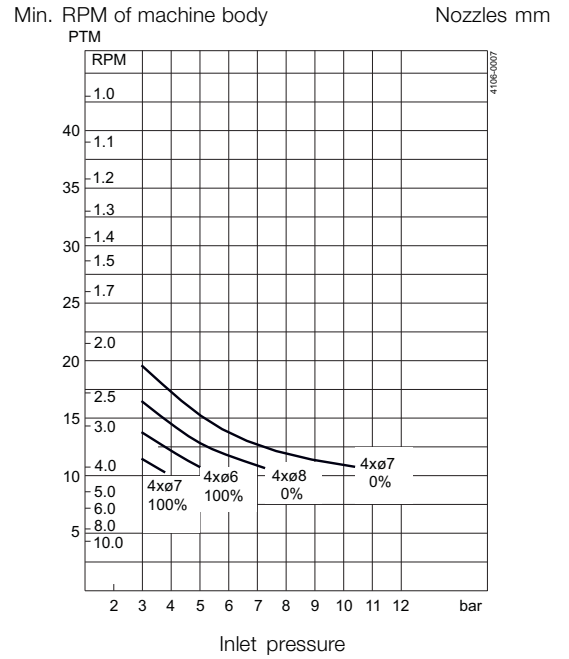

A	B	C	D	E	F	G	H	J
297	170	1½" BSP or 1½" / 2" NPT	204	78	152	ø225	ø264	ø190

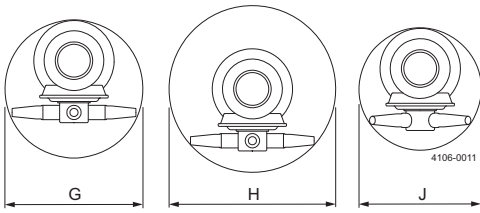

Options

Electronic rotation sensor to verify 3D coverage.

Standard Design

The choice of nozzle diameters can optimise jet impact length and flow rate at the desired pressure. As standard documentation, the Toftejorg TZ-74 Self Cleaning Version can be supplied with a “Declaration of Conformity” for material specifications.

TRAX simulation tool

TRAX is a unique software that simulates how the Toftejorg TZ-74 Self Cleaning Version performs in a specific tank or vessel. The simulation gives information on wetting intensity, pattern mesh width and cleaning jet velocity. This information is used to determine the best location of the tank cleaning machine and the correct combination of flow, time and pressure to implement.

A TRAX demo containing different cleaning simulations covering a variety of applications can be used as reference and documentation for tank cleaning applications. The TRAX demo is free and available upon request.

Wetting Intensity

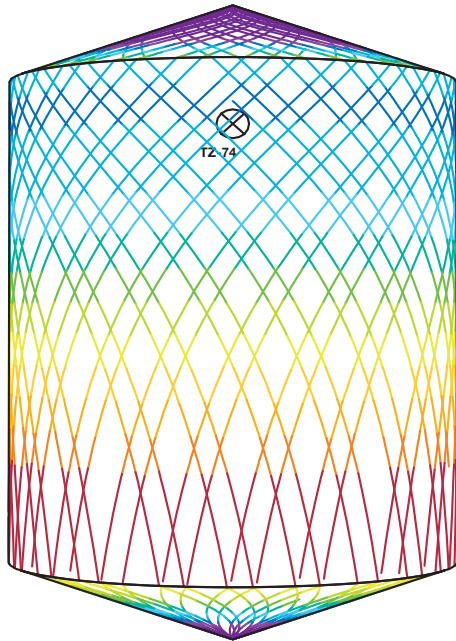
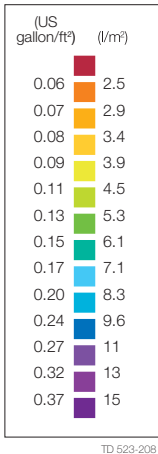

D5m H6m, Toftejorg TZ-74 Self Cleaning version, 4 x ø7 mm, 0% Time = 3.8 min., Water consumption = 1192 l



D5m H6m, Toftejorg TZ-74 Self Cleaning version, 4 x ø7 mm, 0% Time = 15.3 min., Water consumption = 4853 l

How to contact Alfa Laval

Contact details for all countries are continually updated on our website. Please visit www.alfalaval.com to access the information direct.