



Mechanical Seal Products and Services Catalog



Experience In Motion



A Global Leader, A Trusted Partner

Flowserve is the recognized world leader in supplying pumps, seals, valves and associated services to the power, oil, gas, chemical and general industries. Every day our solutions move even the most hazardous fluids and gases safely and securely. Flowserve represents not only a collection of trusted products, but also a single global source that can reduce your total cost of ownership.

Instrumental in this process is the Flowserve line of mechanical seals, support systems and services for pumps and other rotating equipment. These technologically advanced products assist our customers in attaining their goals of increasing reliability and improving process management.

A Guide to Flowserve Seals

This catalog will familiarize you with select mechanical seal products, seal support systems and services designed to improve rotating equipment operations. Industry applications are provided as well as operating parameters, features and equipment suitability for individual products. The symbols shown here are used as a quick reference to help identify the primary industry application.

For more information about Flowserve and to find a location near you, visit our website: www.flowserve.com.



Oil and Gas



Chemical



Power



Water Resources



Mineral and Ore Processing



Pulp and Paper



Pharmaceutical



General Industry



Table of Contents

Introduction	4
Refining & Petroleum Industry.	6
Chemical Industry	7
Power Industry.	8
Pipeline Industry	9
Pulp & Paper Industry	10
Mineral and Ore Processing Industry.	11
Water & Wastewater Industry	12
Pharmaceutical Industry	13
ISC2 Standard Cartridge Seals.	14
Pusher Seals	17
Metal Bellows Seals	22
Mixer Seals.	25
Compressor Seals	29
Slurry Seals	35
Gas Barrier and Containment Seals	38
OEM and Special Duty Seals	41
Seal Support Systems	45
Accessories	50
Seal Design and Operation.	53
Mechanical Seal Piping Plans.	60



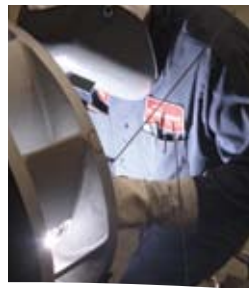

Global Presence, Local Support

Responsiveness Worldwide

Globally, Flowserve operates regional, state-of-the-art manufacturing facilities to provide sealing solutions as a single resource for the improvement of end user customer rotating equipment operations. In cooperation with our alliance customers, we have improved operational efficiencies to world-class standards.

Alliances / LifeCycle Advantage

Flowserve is the undisputed global leader in delivering Total Cost of Ownership (TCO) programs to the fluid handling marketplace because we have the technological leadership, product breadth, service and support, financial stability, and experience with reliability focused programs. With hundreds of successful alliances, Flowserve stands by its documented results and customer references. An alliance customer can select from a variety of programs or create a unique arrangement that best suits their needs, including regional and global plans.

With assistance from the Flowserve Services and Solutions team, all engagements are tailored to meet customer priorities and business strategies. The result is a formal program called LifeCycle Advantage™, a partnership that incorporates performance indicators to measure success and a commercial structure that aligns with customer goals. From traditional arrangements to performance-based, risk-reward contracts, Flowserve has experience designing and administering agreements that help achieve customer business goals.

Quick Response Centers (QRCs)

To meet the end user need for cost reduction, increased seal life and minimal down time, Flowserve has developed a network of Quick Response Centers (QRCs). Strategically located around the world, QRCs are staffed by highly skilled engineers and technicians who are available around the clock, seven days a week, to respond to customer inquiries, evaluate and troubleshoot problems, and provide reliable solutions with quantifiable business results.

Typical facilities are equipped with modern manufacturing capabilities including seal repair and reconditioning as well as the ability to design and produce complete seals. QRCs include complete CAD resources with the ability to quickly design detailed drawings for parts or seals. With this level of local customer focus, the Quick Response Centers are ready to respond to your needs quickly and completely.



Asset Data Management and Educational Resources

FlowsERVE employs a comprehensive collection of tools and technologies to ensure all relevant equipment, unit and plant data becomes part of the decision-making process. Whether employing a wireless monitoring system, leveraging its Technology Advantage™ Platform or making sense of disparate sets of historical data, FlowsERVE can help customers get a more complete view of all their data, including live operational parameters. Asset technologies include:

- Intelligent Process Solutions Wireless (IPS Wireless™)
- Condition Data Point Monitoring (CDPM)
- Advanced vibration measurements and diagnostics
- Special field performance test tools

Once data is collected, proprietary software in Flowstar.net and IPS APEX™ from FlowsERVE allows customers to view actionable information using easy-to-understand graphical interfaces. FlowsERVE and customer experts then collaborate to determine the meaning of data and quickly deploy solutions preventing equipment failures and system disruptions before they occur.

Educational Resources

FlowsERVE education and training provide companies around the world with a wide range of innovative programs focused on helping plant operators, reliability specialists, engineers and maintenance personnel deepen their understanding of flow management equipment and systems. Training programs from FlowsERVE are ideal for organizations seeking:

- Maximized plant asset availability and equipment reliability
- Increased mean time between repair (MTBR)
- Workforce development for increasing proficiency in the installation, design, operation, maintenance and repair of flow management equipment and systems

Customers can choose the location, course content and program formats that optimize the use of human and financial resources and deliver the most effective results. The learning venues vary depending on the type of training requested and can take place at the customer's site, a FlowsERVE regional Learning Resource Center or online.

While customers may select from a menu of standard course offerings, customer training is frequently tailored to address specific requirements based on audience or flow management system issues. A FlowsERVE education and training expert can help develop a program that addresses specific customer goals.

Refining & Petrochemical Industry

Safe and reliable handling of fluid is vital in today's hydrocarbon processing plants. Complex refining techniques generate a broad range of shaft sealing challenges. A growing focus on environmental stewardship demands continuous innovation in process containment. Flowserve's commitment to technology development has produced sealing solutions for:

- Zero emissions on services containing volatile hazardous air pollutants
- Specialized applications including viscous refinery bottoms, polymerizing fluids, and flammable gases
- Corrosive, caustic, acidic, sour and abrasive products
- A wide range of temperatures from sub zero up to 427°C (800°F)
- High speeds and high pressures
- Tolerance to process upsets

API 682 / ISO 21049

Flowserve seals and support systems for the refinery industry satisfy all requirements of the latest edition of API 682.



application	category	model
general purpose, water amines, sour water non-flashing hydrocarbons	standard cartridge pusher metal bellows	ISC2-682 Series QB, QBQ BX, BXQ
caustic	metal bellows	BX, BXQ
flashing hydrocarbons	pusher	QBQ, QBQ LZ
high pressure, crude	pusher	UCQ, UOP
high temperature plan 23, boiler feed water	pusher	D
high temp non-flashing hydrocarbons	metal bellows	BXRH, BXHH
dry gas backup	containment	GSL, GSD
dual pressurized gas seal	gas barrier	GF-200
integrally geared equipment	OEM	GLS, GSS, GSG
turbomachinery	compressor	Gaspac, Circpac

Chemical Industry

Modern chemical plants produce a tremendous variety of products over a wide range of operating conditions. Next to safe handling of toxic products, good corrosion resistance, reliability and low cost are of great importance.

Critical needs are:

- Resistance to highly corrosive liquids
- A wide range of materials of construction
- Resistance to abrasive substances
- Ability to stand up under highly toxic, volatile and flammable fluid service
- Low leakage rates or zero product leakage
- Low cost but durable designs for stuffing box retrofits
- Maximum interchangeability of components to reduce inventories

ASME / ISO / JIS

Flowserve has a wide range of products to cover ASME (ANSI), ISO (DIN and EN) and JIS pump standards, which are most commonly used in the chemical industry. Engineered designs for pumps and mixers are also part of the product range.

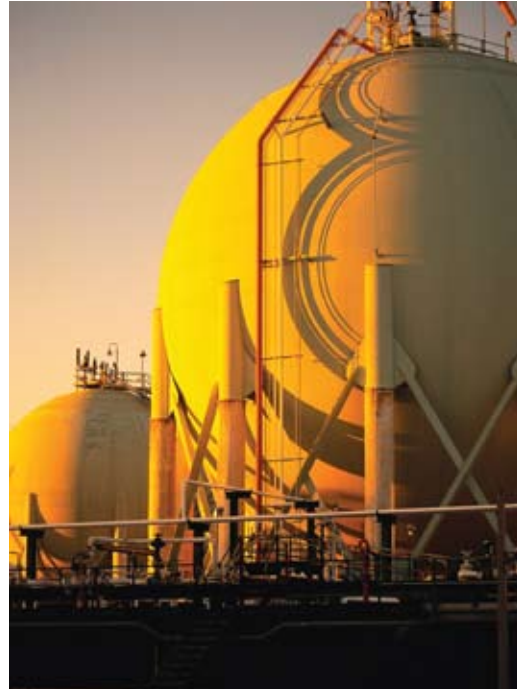

application	category	model
most low viscosity, mildly corrosive chemicals, water, process water, caustics, mild acids, non-flashing low temperature hydrocarbons	standard cartridge pusher metal bellows slurry special duty	ISC2 Series RO, Europac 600-610 BX, BXLS Allpac Pac-Seal
high temperature/heat transfer	metal bellows	BXHH, BXRH
high viscosity, slurry	slurry	SLM, Allpac
most clean, low viscosity chemicals	gas barrier	GX-200, GF-200
acids, corrosive chemicals	pusher	RA, RA-C
integrally geared equipment	OEM	GLS/GSS/GSG
mixers	mixer mixer standard cartridge	M Series, Mixerpac VRA, MSS ISC2-MW

Power Industry

As generating stations continue to increase in size, output and complexity, sealing devices with an ever-greater range of speed, pressure and temperature capability are required. In hot water applications, these factors create difficult lubrication conditions between the seal faces requiring specialized solutions in materials, cooling features, and seal face features to achieve long mechanical seal life.

In the critical sealing of boiler feed and boiler circulation water, Flowserve continues to innovate new technology to optimize and extend performance. Station operators turn to Flowserve to provide a safer, lower maintenance working environment.

Flowserve development has created solutions for:

- High speeds on large shaft diameters
- High pressures and high temperatures on water
- Minimum reaction to temperature transients
- Hot standby and slow roll capability
- Electrocorrosion effects apparent in high purity feed water
- Abrasive slurries used in flue gas desulphurization

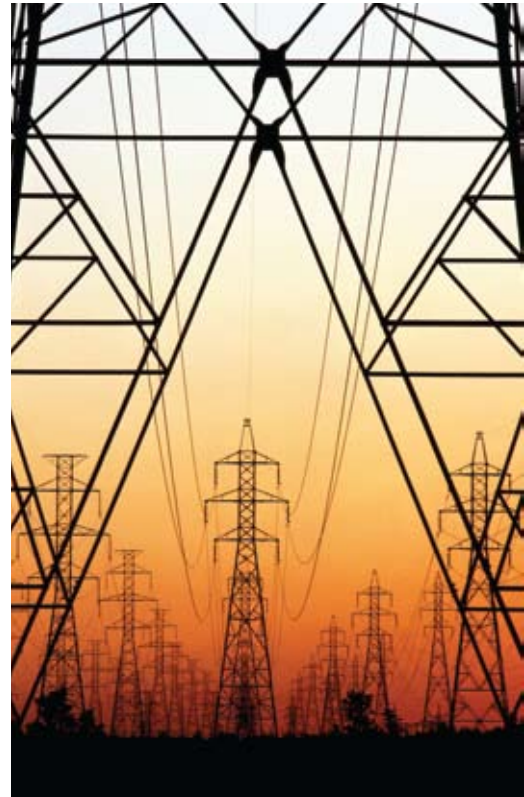

application	temperature	pressure	cooling	category	model
water, condensate	low low	low low	none none	standard cartridge special duty	ISC2 Series PSS III
boiler feed water	medium	medium	none	pusher	QBU
	medium	medium	Plan 23	pusher	Europac 615
	high	high	Plan 23	pusher	D, DP
	high	very high	Plan 23	pusher	DHTW
blowers	high	low	none	special duty	Circpac MD
flue gas desulphurization	low	low	none	slurry	SLM
	low	low	none	slurry	SLC
	low	low	none	slurry	RIS

Pipeline Industry

Pipelines are an economical and reliable way to transport large quantities of liquid when the unique characteristics of the complete system are addressed. Pipelines move fluids within the natural resource recovery region, transport raw products to refineries, and transfer refined products to distribution points. Operators may use batch type transport to send various refined products ranging from fuel oils to Liquefied Natural Gas (LNG), often at varying pressures through a single pipeline.

Supercritical fluids which normally exist as gases, such as ethane, CO₂, and natural gas are pumped in their dense phase and pose unique sealing challenges.

Mechanical seals are relied on to seal critical pumps in remote locations without access to clean flush fluids and provide operators early leakage detection so they can react in time to prevent spills.

Flowsolve applies industry-leading technology in proven products that meet these special pipeline industry needs:

- Dependable performance in unattended main and booster station service
- Operation under high pressures and very high speeds
- Ability to handle a wide array of fluids of varying specific gravities from light hydrocarbons to viscous crude bitumen
- Supercritical, dense phase fluids
- High resistance to dirt and abrasives
- Reliable sealing and low leakage despite radical fluctuations in temperature
- Performance in intermittent service, with many stops and high pressure start-ups



application	pressure	category	model
flashing light hydrocarbons	medium	pusher	QBQ, QBQ LZ
hydrocarbons, crude oil	low	metal bellows	BXQ
	medium	pusher	QBQ
	high	pusher	HSB, UOP
	very high	pusher	UHTW
dry lift-off gas back-up	medium	containment	GSL
produced water	low	metal bellows	BX
	medium	slurry	Allpac
	medium	pusher	QB
	very high	pusher	UHTW
dense phase fluids, CO ₂	very high	pusher	UHTW, Gaspac T

Pulp & Paper Industry

Paper stock, black liquor, chlorine, coating mixes, pumps, refiners, screens and agitators are common in the pulp and paper industry. Processing wood or waste paper and transforming it into paper or board requires cutting, grinding, cleaning, bleaching and de-watering operations. Reduction of energy and water usage is important to reduce operating cost. Flowserve has developed advanced seals and sealing systems that can help you reduce your plant's water, energy and maintenance costs:

- Resistance to highly corrosive liquids
- Resistance to abrasive substances
- A wide range of materials of construction
- Low leakage rates
- Low cost but durable designs for stuffing box retrofits
- Maximum interchangeability of components to reduce inventories



application	equipment	category	model
paper stock	pumps	standard cartridge	ISC2 Series
	pumps	special duty	PSS III
	pumps	slurry	SLM, Allpac
specialty equipment	refiners, conveyors	bellows	BX
	axial flow circulators	special duty	PSS III
	pulpers	slurry	SLM

Mineral and Ore Processing Industry

Alumina, cement, clay, coal, copper, gold, gypsum, mineral sands, nickel, phosphate, potash, silver, trona, taconite, titanium, zinc; whatever the process, mineral and ore can represent one of the toughest machinery and sealing environments around. Taking raw material from the earth and refining finished mineral products requires rugged equipment capable of surviving abrasive and corrosive services, often at extreme pressures and temperatures.

Flowserve delivers advanced sealing systems to decrease maintenance expenditures, limit or eliminate water usage, maintain safety and reliability, and help reduce plant energy costs. Our products and services are designed to accomplish all this while ensuring equipment availability with increased meantime between planned maintenance, ultimately allowing for higher production by having:

- Resistance to highly abrasive liquid slurries
- Resistance to highly corrosive substances
- A wide range of materials of construction for long seal life
- Maximum interchangeability of components to reduce inventories
- Ability to isolate highly toxic and corrosive fluids from the atmosphere



- Recoverability from low or lost suction upset conditions
- No product diluting flush requirements

application	slurry	category	model
slurry pumps	heavy medium light	slurry slurry standard cartridge	SLC, SLM-6200 SLM-6000, Allpac ISC2 Series
agitators / autoclave		mixer seal	M Series
accessories		accessories	SLD, QCD, EPD
axial flow circulators		special duty	PSS III

Water & Wastewater Industry

Water is the most common liquid on earth yet is a precious commodity and deserving of sustainable handling. It is used for many purposes, such as drinking, cooling, heating, irrigation, processing and sanitation.

Wastewater treatment plants have two basic purposes: to speed up the purification process occurring naturally in rivers, lakes and streams, and to reduce toxic contaminants that can interfere with natural processes. Typical applications can involve chemicals, solids and slurries.

As government regulations on water quality increase, the cost of water treatment and the value of clean water increase. Flowserve seals and sealing systems can offer a significant savings in operating costs:

- Low leakage rates
- Reliability
- Resistance to contamination and abrasives
- Low cost but durable designs for stuffing box retrofits
- Maximum interchangeability of components to reduce inventories
- Reduce or eliminate environmental contamination



application	category	model
water	standard cartridge	ISC2 Series
	pusher	RO
	pusher	Europac 600-610
	special duty	PSS III
	special duty	Pac-Seal
sludge	slurry	SLM
	slurry	Allpac

Pharmaceutical Industry

Continuous development of new drugs and healthcare products expand the capabilities and challenges of the pharmaceutical industry. Manufacturers of pharmaceutical products likewise refine their processes to improve the performance of their rotating equipment and remain compliant with regulations. Lower emissions and improved purity of end products are the two main focuses with sealing rotating equipment, along with being a good community neighbor.

Flowsolve has close relationships with many of the end users and specialty equipment manufacturers and knows the industry requirements:

- No product contamination allowed
- Low or no emissions to atmosphere
- A wide range of materials of construction including food grade compatible
- Low leakage rates
- Electropolish finishes available on critical metal surfaces for ease of cleaning and increased sanitary protection
- Sanitary glands and debris wells
- Application experience sealing high-alloy and glass-lined vessels
- A long history of experience sealing top entry, side entry and bottom entry mixer and agitator equipment with great success
- Very low speeds to very high speeds with gas seal designs
- Cryogenic vacuums to very high pressure and high temperature autoclaves with dual seals
- Seals are designed for clean-in-place (CIP) and steam-in-place (SIP) applications as well as the ability to stand up to caustics and acid flushes between batches



application	category	remark	model
mixers, agitators, blenders, dryers	mixer	wet or dry dual pressurized	M Series
	mixer	CIP/SIP dry lift-off dual	Mixerpac 2568 / 2570
	standard cartridge	wet dual pressurized	ISC2-MW
	mixer	dry contacting single	VRA
	mixer	split seal	MSS
autoclaves, centrifuges	mixer	wet dual pressurized	MW-200
	mixer	dry contacting dual pressurized	MD-200
	mixer	dry lift-off dual pressurized	ML-200
bioreactors	mixer	bottom entry	ST
	mixer	side entry	Mixerpac 589
pumps	standard cartridge	single or dual	ISC2 Series
	special duty	split seal	PSS III



ISC2 standard cartridge seals

ISC2 seals are the most capable and versatile general purpose family of cartridge seals available, meeting all international standards (ASME, DIN, ISO, JIS, and others) and designed to fit hundreds of pump models from global manufacturers. ISC2 seals are capable of providing uninterrupted, long-term operation even with multiple service conditions, off-design operation and frequent stops and starts.

Facilities in chemical processing, petrochemical, pulp and paper, water and wastewater, mining, power, tank farms and other industries that standardize to ISC2 seals for general purpose applications will immediately benefit from ease of installation, less inventory, greater flexibility, rapid availability, less downtime and longer seal life.

Cartridge seals are factory assembled, pre-tested complete units. Each seal is backed by 24-hour support, on-site service, engineering analysis, seal repair capabilities, customized stocking programs and on-time delivery.

ISC2-PX	15
ISC2-PP	15
ISC2-BX	15
ISC2-BB	16
ISC2-682	16
ISC2-MW	16

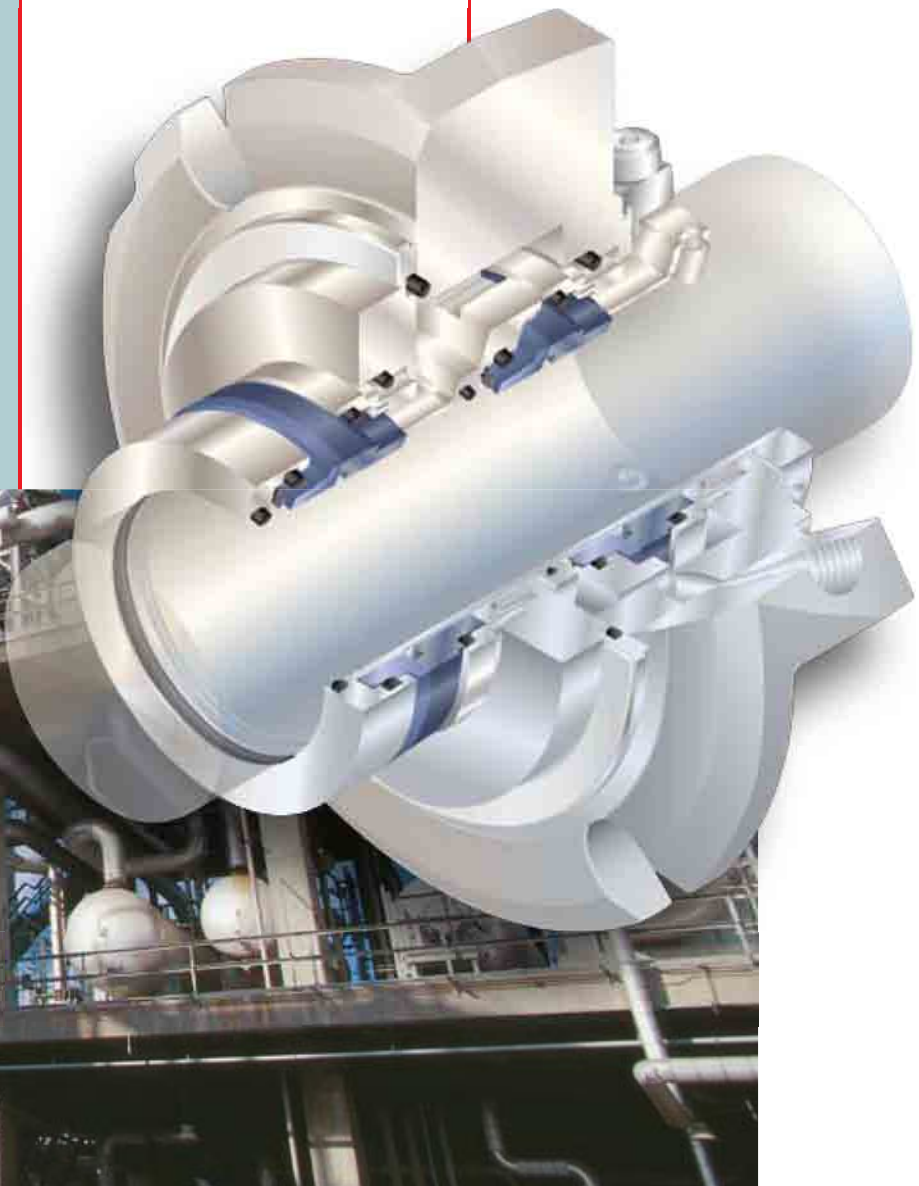

ISC2-PX
Single cartridge pusher seals

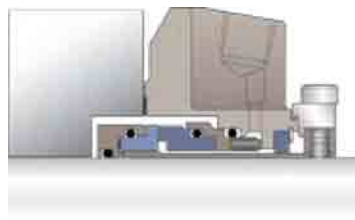

Equipment Type

- General purpose ASME, ISO, JIS pumps

Operating Parameters

Pressure up to 20.6 bar (300 psi)
 Temperature -40 to 204°C (400°F)
 Speed up to 23 m/s (75 fps)
 Shaft Sizes 25 to 200 mm
 (1.000 to 8.000 inch)

Features

- Single cartridge pusher seals
- Applied in a wide variety of general purpose industrial applications and equipment
- Thermal management technology helps the seal run cooler and tolerate dry running events
- Stationary face support drive mechanism reduces wear in applications with high vibration levels
- For sizes larger than 70 mm (2.750 inch), the stationary support drive mechanism allows a larger range of dynamic movement commonly found in larger equipment
- Throttle bushing provides safe containment in the unlikely event of a seal failure
- Springs and pins are outside the product for reduced corrosion
- Available in a wide range of materials

Reference FSD243

ISC2-PP
Dual cartridge pusher seals

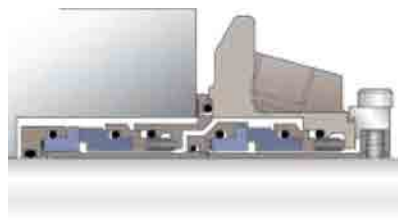

Equipment Type

- General purpose ASME, ISO, JIS pumps

Operating Parameters

Pressure up to 20.6 bar (300 psi)
 Temperature -40 to 204°C (400°F)
 Speed up to 23 m/s (75 fps)
 Shaft Sizes 25 to 200 mm
 (1.000 to 8.000 inch)

Features

- Dual cartridge pusher seals
- Applied in a wide variety of general purpose industrial applications and equipment
- Advanced design volute groove significantly increases barrier fluid flow to promote cool running
- The seal arrangements are tandem and double balanced to allow both pressurized and unpressurized operation
- Stationary face support drive mechanism reduces wear in applications with high vibration levels
- For sizes larger than 70 mm (2.750 inch), the stationary support drive mechanism allows a larger range of dynamic movement commonly found in larger equipment
- Springs and pins are outside the product for reduced corrosion
- Available in a wide range of materials

Reference FSD243

ISC2-BX
Single metal bellows seals

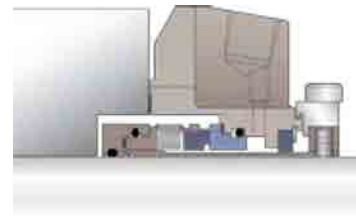

Equipment Type

- General purpose ASME, ISO, JIS pumps

Operating Parameters

Pressure up to 13.8 bar (200 psi)
 Temperature -40 to 204°C (400°F)
 Speed up to 23 m/s (75 fps)
 Shaft Sizes 25 to 95 mm
 (1.000 to 3.750 inch)

Features

- Single cartridge metal bellows seals
- Applied in a wide variety of general purpose industrial applications and equipment
- Thermal management technology helps the seal run cooler and tolerate dry running events
- Edge-welded bellows of Alloy C-276 metallurgy are well suited for a wide range of chemical environments
- Metals bellows maintain excellent seal face loading without hanging up due to solids build-up
- Throttle bushing provides safe containment in the unlikely event of a seal failure
- Available in a wide range of materials

Reference FSD243

ISC2-BB

Dual metal bellows seals



Equipment Type

- General purpose ASME, ISO, JIS pumps

Operating Parameters

Pressure up to 13.8 bar (200 psi)
 Temperature -40 to 204°C (400°F)
 Speed up to 23 m/s (75 fps)
 Shaft Sizes 25 to 95 mm
 (1.000 to 3.750 inch)

Features

- Dual cartridge metal bellows seals
- Applied in a wide variety of general purpose industrial applications and equipment
- Advanced design volute groove significantly increases barrier fluid flow to promote cool running
- The seal arrangements are tandem and double balanced to allow both pressurized and unpressurized operation
- Edge-welded bellows of Alloy C-276 metallurgy are well suited for a wide range of chemical environments
- Available in a wide range of materials

Reference FSD243

ISC2-682

ISC2 seals compliant to API 682

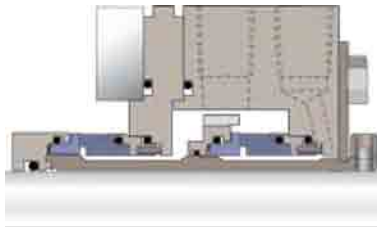

Equipment Type

- API 610 or ASME enlarged bore pumps

Operating Parameters

Pressure
 pusher up to 20.6 bar (300 psi)
 bellows up to 13.8 bar (200 psi)
 Temperature -40 to 204°C (400°F)
 Speed up to 23 m/s (75 fps)
 Shaft Sizes
 pusher 25 to 200 mm
 (1.000 to 8.000 inch)
 bellows 25 to 95 mm
 (1.000 to 3.750 inch)

Features

- Seals satisfy all API 682 design and qualification test requirements
- Configurable as either Type A pusher seal or Type B metal bellows seal to suit specific applications
- Available in all API 682 standard arrangements including single, dual unpressurized and dual pressurized
- Designs are built on ISC2 seal basic components, sharing the benefits of thermal management technology, volute groove design and Alloy C-276 bellows
- Built for general duty refinery and chemical plant services

Reference FSD243

ISC2-MW

Dual pusher seal for mixer service

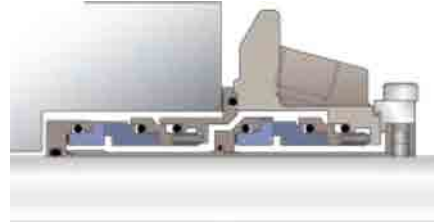

Equipment Type

- Mixers

Operating Parameters

Pressure up to 6.9 bar (100 psi)
 Temperature -40 to 204°C (400°F)
 Speed up to 1.1 m/s (3.5 fps)
 Shaft Sizes 25 to 200 mm
 (1.000 to 8.000 inch)

Features

- Economical cartridge seal for top entry installations
- Dual wet design
- Thermal management technology helps the seal run cooler and tolerate dry running events
- 1.14 mm (0.045 inch) TIR on sizes up to 89 mm (3.500 inch) shaft size
- 1.52 mm (0.060 inch) TIR on sizes greater than 89 mm (3.500 inch) shaft size
- Volute groove significantly increases barrier fluid flow to promote cool running even at mixer speeds

Pusher Seals

Mechanical seals categorized as pusher seals represent an extremely popular and successful style of sealing. A pusher seal relies on the sealability of a flexible element such as an O-ring or U-cup between the seal face and adjoining surface. The assembly of seal faces, spring(s) and flexible element working together is the foundation for proper seal performance. Flowserve's diverse portfolio is well suited to address numerous application and industry requirements.

Pusher seal designs run the gamut from simple, low duty devices to the highest duty, extremely sophisticated engineered solutions. Besides general services, pusher seals are often selected for light hydrocarbons, high pressures and high speed applications because of their inherently greater strength and damping characteristics compared to bellows seals.

Modern flexible secondary sealing materials allow an ever expanding application of pusher seals. Availability of materials by size, chemical resistance, hardness, and shape is unprecedented and few services exist where O-rings in particular cannot be used.

The most common spring arrangement utilizes multiple small diameter coil springs of a high metallurgy evenly distributed around the seal face. Large section single coil springs are used where long axial travel is required or to prevent clogging. Locating the springs outside the process fluid is another viable solution to avoid clogging with product debris. In axially-compact designs, wave springs can be used.

Besides the versatility of pusher seals and expansive field experience, another compelling attribute is their reparability after years of operating. If the time comes for a repair, pusher seals can generally be repaired quickly and returned to service.



QB	18
QBB/QB	18
QBQ LZ/GSL.....	18
UC	19
D.....	19
DHTW.....	19
HSH	20
RO	20
CRO	20
Europac 600.....	21
RA	21



QB

General purpose pusher seals

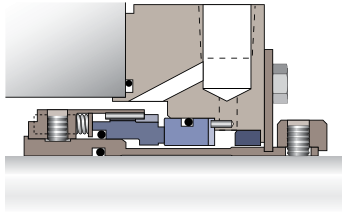

Equipment Type

- Pumps, including API 610

Operating Parameters

Pressure up to 51.7 bar (750 psi)
 Temperature -40 to 204°C (400°F)
 Speed up to 23 m/s (75 fps)
 Shaft Sizes 12.7 to 139.7 mm
 (0.500 to 5.500 inch)

Features

- General industry single, balanced, multi-spring, pusher seal
- Welded keys drive rotating seal face providing robustness to high torque scenarios
- A wide range of available features enable improved performance in challenging applications
- Choice of throttle bushing design: fixed, floating, segmented

Other Configurations

QBQ

- Standard API 682 Arrangement 1 Type A seal
- High balance seal face design for low emissions. Faces designed to suppress flashing and minimize heat generation in hydrocarbon applications

QBS

- Single spring design provides the highest resistance to clogging and corrosion

QBU

- Grooved face option designed for hot water applications where cooling water is not available

QBR

- Reverse configuration with stationary flexible element. Standard hydraulic decoking jet pump seal

Reference FSD152, FSD175

QBB/QB

Dual pressurized pusher seals capable of zero emissions

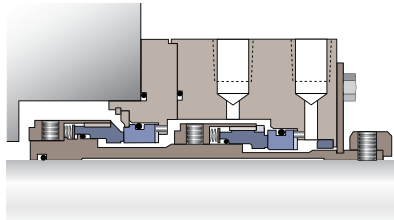

Equipment Type

- Pumps, including API 610

Operating Parameters

Pressure up to 51.7 bar (750 psi)
 Temperature -40 to 204°C (400°F)
 Speed up to 23 m/s (75 fps)
 Shaft Sizes 20 to 127 mm
 (0.787 to 5.000 inch)

Features

- Standard API 682 Arrangement 3 Type A seal for pressurized barrier configurations
- Extremely robust to reverse pressurization with reverse pressure handling capabilities that far exceed conventional balanced seals
- Seal face geometry enables use of face to back configuration which is preferred in many dual seal applications
- Integral pumping ring

Other Configurations

QBQ/QBQ

- Standard API 682 Arrangement 2 Type A seal for use with a liquid buffer fluid
- High balance low emissions for hydrocarbon down to 0.45 specific gravity

Reference FSD152

QBQ LZ/GSL

Dual unpressurized pusher seals with containment seals

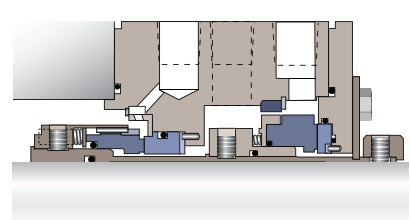

Equipment Type

- Pumps, including API 610

Operating Parameters

Pressure up to 51.7 bar (750 psi)
 Temperature -40 to 204°C (400°F)
 Speed 6.1 to 23 m/s (20 to 75 fps)
 Shaft Sizes 20 to 116 mm
 (0.787 to 4.567 inch)

Features

- API 682 Arrangement 2 Type A seal for use with a buffer gas
- Specially designed for light hydrocarbons at low vapor pressure margin
- Precision face topography combats vaporization by increasing fluid pressure between the seal faces and reducing heat generation
- Specific gravities between 0.4 and 0.6
- Dry-running lift-off containment seal provides near zero emissions and safety backup

Other Configurations

QBQ LZ/QBQ

- API 682 Arrangement 2 Type A seal for use with a liquid buffer fluid

Reference FSD216, FSD143

UC

Single spring pusher seals

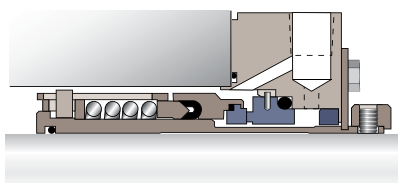

Equipment Type

- Pumps, including API 610, pipeline

Operating Parameters

Pressure	up to 27.6 bar (400 psi)
Temperature	-40 to 204°C (400°F)
Speed	up to 23 m/s (75 fps)
Shaft Sizes	14.1 to 148 mm (0.566 to 5.838 inch)

Features

- Workhorse pusher seal with thick section components is suitable for tough dirty services
- Large cross section elastomer U-cup dynamic gasket
- Graphite gasketed silicon carbon rotating face provides excellent heat transfer
- Canned face provides optimum face flatness

Other Configurations

UCQ

- API 682 Arrangement 1 Type A seal
- High balance low emission light hydrocarbon design, specific gravities down to 0.45 with multiport flush

UO

- High pressure rotating face design for applications between 27.6 bar (400 psi) and 69 bar (1000 psi)

UOP

- High pressure rotating and stationary face for applications between 51.7 bar (750 psi) and 103.4 bar (1500 psi)

Reference FSD110

D

Single spring pusher seals

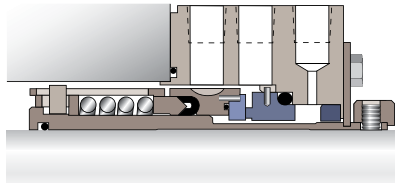

Equipment Type

- Pumps, including API 610

Operating Parameters

Pressure	up to 69 bar (1000 psi)
Temperature	-73 to 343°C (-100 to 650°F)
Speed	up to 23 m/s (75 fps)
Shaft Sizes	13.4 to 137 mm (0.525 to 5.400 inch)

Features

- High circulation integral pumping ring optimized for use in conjunction with Plan 23 closed loop cooling
- Ideal for boiler feed water and hot water service
- Large cross section elastomer U-cup dynamic gasket

Other Configurations

DQ

- API 682 Arrangement 1 Type A seal
- High balance low emission hot hydrocarbons

DP

- High pressure stationary face, 51.7 to 103.4 bar (750 to 1500 psi)

Reference FSD153

DHTW

High speed, high pressure balanced pusher seals

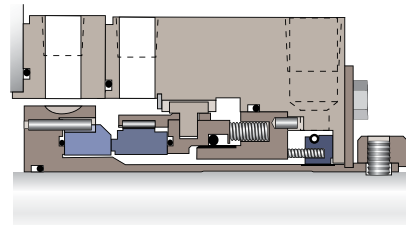

Equipment Type

- Pumps, including API 610, pipeline

Operating Parameters

Pressure	up to 207 bar (3000 psi)
Temperature	-40 to 371°C (700°F)
Speed	up to 76 m/s (250 fps)
Shaft Sizes	25.4 to 228.6 mm (1.000 to 9.000 inch)

Features

- Custom engineered for specific applications in high energy pumps such as boiler feed process barrel pumps
- Seal faces designed using FEA techniques allow for zero net deflection from thermal, hydraulic, and dynamic forces
- Available anti-electrical corrosion features for ultra high purity boiler feed water
- Precision face topography available to provide optimal lubrication
- Integral pumping ring designs optimized for each application's speed
- Extra heavy duty face geometry and drive features suitable for high torque, high pressure, and high speed

Other Configurations

UHTW

- As DHTW, without the integral pumping ring

UHTW/DHTW

- Dual seal arrangement available for the most robust applications where leakage and emissions control are critical
- Applications include: hydrocarbons, CO₂, boiler circulation, pipelines, and oil field injection

Reference FSD140

HSH

Stationary spring design seals

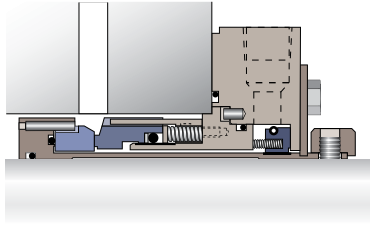

Equipment Type

- Pumps, including API 610, pipeline

Operating Parameters

Pressure	up to 103 bar (1500 psi)
Temperature	-40 to 204°C (400°F)
Speed	up to 46 m/s (150 fps)
Shaft Sizes	38.1 to 177.8 mm (1.500 to 7.000 inch)

Features

- Built for high pressure, high speed, highly viscous services
- Flexible stator design allows for high speed operation and adapts to handle pump casing misalignment in axial split pumps
- Anti-rotation lugs provide high torque capability
- Thick cross-section faces designed with FEA techniques provide high pressure capability
- Lapped face support surfaces stabilize the effects of mechanical and thermal loads

Reference FSD156

RO

Unbalanced pusher seals

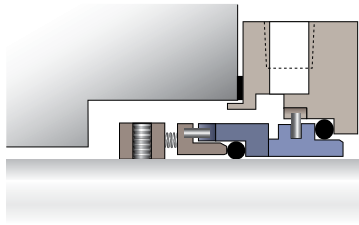

Equipment Type

- ASME pumps

Operating Parameters

Pressure	up to 20.7 bar (300 psi)
Temperature	-40 to 260°C (500°F)
Speed	up to 23 m/s (75 fps)
Shaft Sizes	9.5 to 115 mm (0.375 to 4.500 inch)

Features

- Single, unbalanced, multi-spring seals that can be used as an inside or outside seal
- Use in abrasive, corrosive and viscous fluids in chemical services
- Heavy cross sections of the rotary components resist high levels of corrosion
- Open rotating spring compression unit aids in keeping solids from packing around the seal faces and improves removal of seal face generated heat
- Individual parts are completely interchangeable and easy to replace

Other Configurations

RO-TT

- Supplied with PTFE V-rings

Reference FSD155

CRO

Coil spring seals

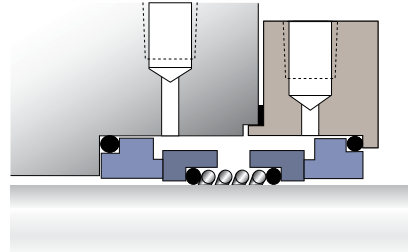

Equipment Type

- ASME pumps

Operating Parameters

Pressure	up to 20.7 bar (300 psi)
Temperature	-40 to 260°C (500°F)
Speed	up to 23 m/s (75 fps)
Shaft Sizes	9.5 to 115 mm (0.375 to 4.500 inch)

Features

- Single spring, pusher seal available in single or dual version (dual shown)
- Use with water or similar viscosity product
- Friction between dynamic gasket and pump shaft provides drive
- Metal parts of the seal are isolated from pumped product to prevent possible chemical or abrasive attack
- Easy to install

Other Configurations

CRO-P

- Positive drive version can be used with liquids having lubricating properties greater than that of water

Reference FSD169

Europac 600

Single unbalanced, wavy spring seals

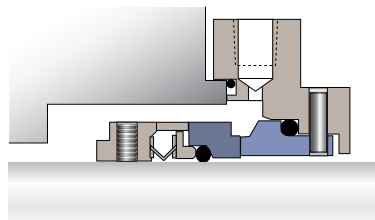

Equipment Type

- ISO pumps

Operating Parameters

Pressure up to 10 bar (145 psi)

Temperature -40 to 220°C (430°F)

Speed up to 23 m/s (75 fps)

Shaft Sizes 10 to 100 mm
(0.394 to 3.940 inch)

Features

- Single, unbalanced, single wavy spring seal
- Applied on a wide range of duties, primarily in the chemical industry
- Designed according to metric DIN EN 12 756 standard to L1k

Other Configurations

Europac 610

- Balanced version fits a stepped shaft, pressure to 25 bar (360 psi)

Europac 615

- Equipped with lube-groove design for hot water services without cooling. Pressure 0 to 17.5 bar (255 psi), temperature -40 to 170°C (340°F)

Reference FSD128

RA

Single, outside mounted pusher seals

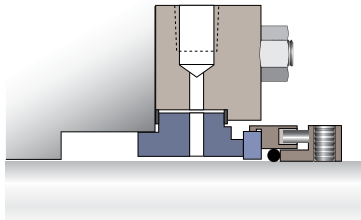

Equipment Type

- General purpose pumps

Operating Parameters

Pressure up to 27.6 bar (400 psi)

Temperature -40 to 177°C (350°F)

Speed up to 23 m/s (75 fps)

Shaft Sizes 13 to 127 mm
(0.500 to 5.000 inch)

Features

- Use in highly corrosive chemical services
- Seal faces and elastomers are the only wetted components and are available in a wide range of materials for proper corrosion resistance
- Flexible rotor design is hydraulically balanced to provide proper face loading for extended reliability
- Easy to install

Other Configurations

RA-C

- Version used with chemical products in plastic, glass, and other non-metallic pumps. There are no wetted metal parts for the highest corrosion resistance

Reference FSD170

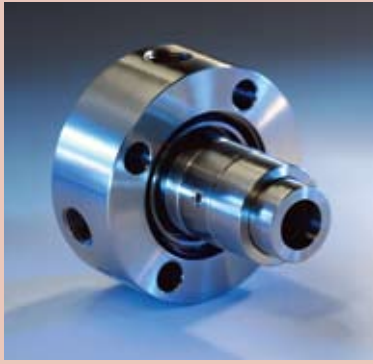

BX	23
BXB/BX	23
BXRH	23
BXHH	24
BXHHS/GSDH	24
BRC	24

Metal Bellows Seals

While pusher seals have an intermediate flexible element acting between a seal face and adjoining surface, metal bellows seals use an assembly of edge-welded metal leaflets as the flexible element. High alloy metal bellows provide spring loading for face contact, create a pressure barrier for optimum seal performance and absorb axial shaft movement while retaining the seal face. Without a dynamic gasket, metal bellows seals are applied in a range of applications otherwise untenable with a dynamic gasket pusher seal design:

- High temperature applications up to 427°C (800°F)
- Large axial travel requirements especially at high temperatures
- Corrosive chemicals that degrade elastomers and other dynamic gaskets

Rotating bellows have a beneficial self-cleaning action through centrifugal effects that resist clogging of process solids in the bellows. Solids and wear debris may accumulate on the atmospheric side of the seal faces without hanging up the dynamic contact of the seal faces. Stationary bellows applied to high temperature hydrocarbons are often fitted with a hot steam quench to avoid coking and potentially compromising seal integrity.

Flowserve has proven experience applying metal bellows seals to general and critical services, from hazardous chemicals to refinery processing including full compliance to API 682 requirements. Configured as single, dual unpressurized or dual pressurized, metal bellows seals provide a high degree of reliability and long term performance.

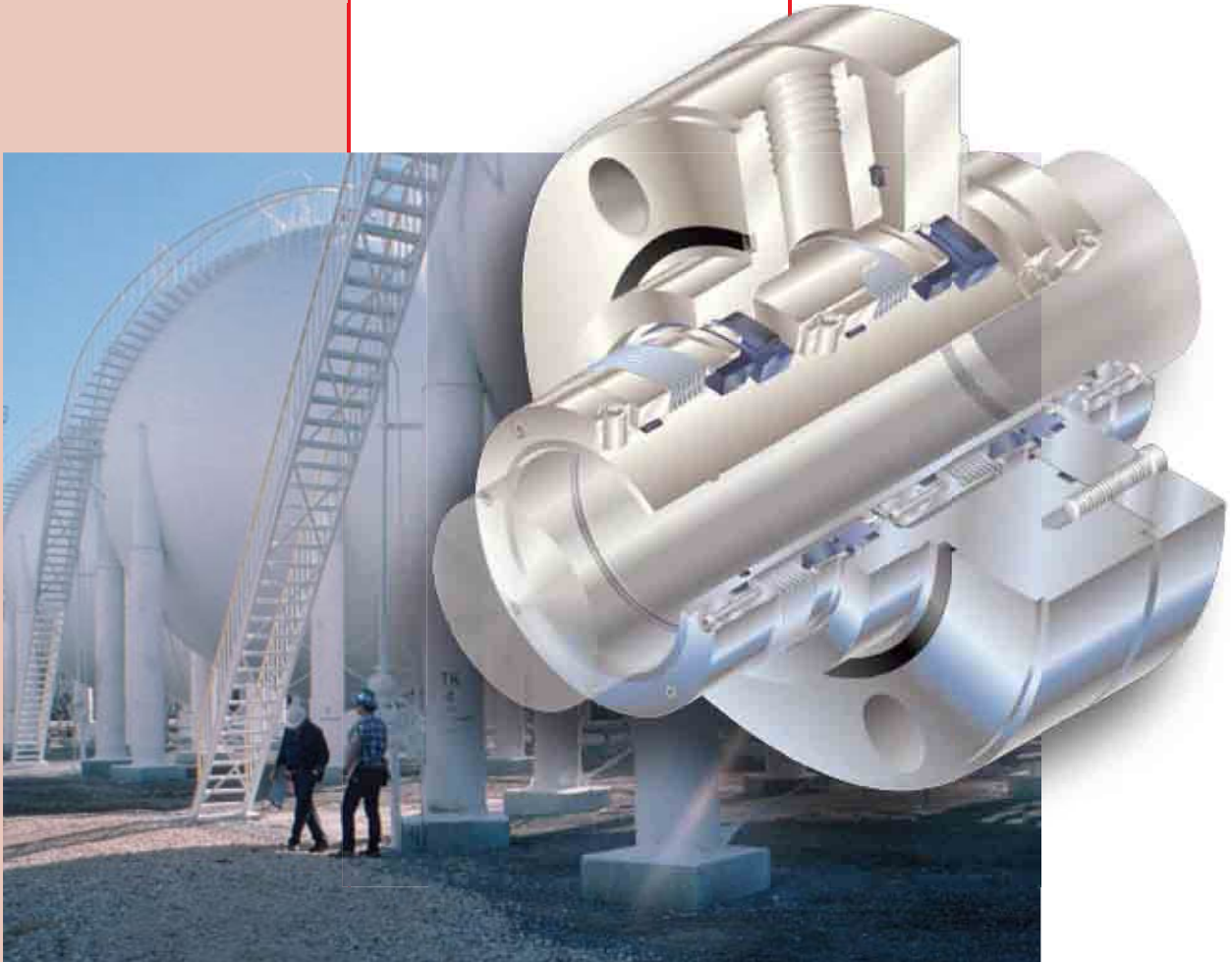

BX

Single welded metal bellows seals

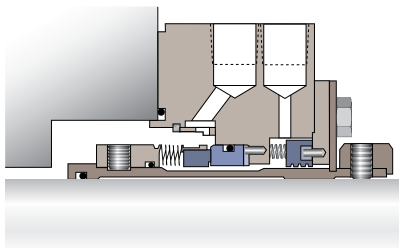

Equipment Type

- Pumps, including API 610

Operating Parameters

Pressure	up to 27.6 bar (400 psi)
Temperature	-40 to 204°C (400°F)
Speed	up to 23 m/s (75 fps)
Shaft Sizes	12.3 to 152.4 mm (0.483 to 6.000 inch)

Features

- General purpose rotating metal bellows seal
- Inherently balanced design
- 0.20 mm (0.008 inch) thick standard welded bellows for high corrosion and vibration resistance
- Rotating bellows design acts to clear convolutions and prevent accumulation of debris
- Bellows available in Alloy 316, Alloy C-276, and Alloy 400 to allow application in a variety of corrosive fluids

Other Configurations

BXQ

- Standard API 682 Arrangement 1 Type B seal
- High balance low emission hydrocarbon design for specific gravities down to 0.45 with multipoint flush

BXLS

- Designed to international standard DIN EN 12 756 L1k for use in DIN pumps

BXR

- Stationary bellows design capable of speeds up to 46 m/s (150 fps)

Reference FSD109

BXB/BX

Dual rotating metal bellows seals

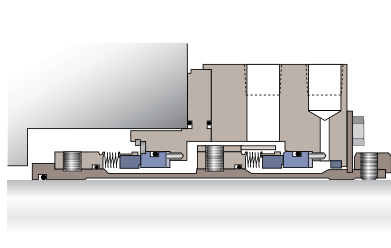

Equipment Type

- Pumps, including API 610

Operating Parameters

Pressure	up to 27.6 bar (400 psi)
Temperature	-40 to 204°C (400°F)
Speed	up to 23 m/s (75 fps)
Shaft Sizes	21.8 to 127 mm (0.857 to 5.000 inch)

Features

- Ideal for API 682 Arrangement 3 Type B pressurized barrier configurations
- Dual pressurized seal configuration for zero emissions and products not suitable to lubricate seal faces
- Inner bellows designed for ID pressurization with barrier fluid
- Enhances the self-cleaning advantage of a rotating bellows in dirty fluids by providing a clean source for face lubrication

Other Configurations

BXQ/BXQ

- Standard API 682 Arrangement 2 Type B unpressurized dual seal
- High balance low emissions for hydrocarbons with specific gravities down to 0.45

Reference FSD109

BXRH

Single stationary metal bellows seals

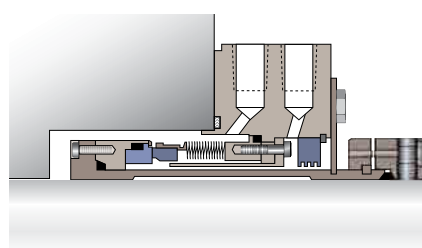

Equipment Type

- High-temperature pumps, including API 610

Operating Parameters

Pressure	up to 20.7 bar (300 psi)
Temperature	-73 to 427°C (-100 to 800°F)
Speed	up to 46 m/s (150 fps)
Shaft Sizes	21.8 to 127 mm (0.857 to 5.000 inch)

Features

- API 682 Arrangement 1 Type C seal standard configuration
- Alloy 718 heat-treated bellows
- Standard anti-coke device helps keep atmospheric side clean
- Distortion free face design maintains face flatness throughout operating range
- Extended travel bellows core allows for extreme linear shaft growth, typical in high temperature pumping
- Flexible graphite gasketing in lieu of elastomers improves temperature and chemical compatibility
- Stationary metal bellows seal tolerates high shaft speeds and lack of seal chamber perpendicularity

Reference FSD111

BXHH

Single rotating metal bellows seals

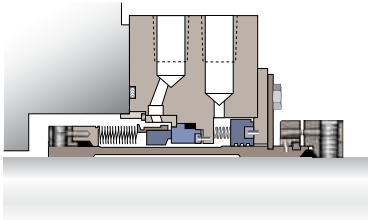

Equipment Type

- High-temperature pumps, including API 610

Operating Parameters

Pressure up to 20.7 bar (300 psi)
 Temperature -73 to 427°C (-100 to 800°F)
 Speed up to 23 m/s (75 fps)
 Shaft Sizes 28.2 to 128.9 mm
 (1.110 to 5.073 inch)

Features

- API 682 Arrangement 1 Type C seal alternate configuration
- Alloy 718 heat-treated bellows
- Rotating bellows design acts to clear convolutions and prevent accumulation of debris
- Distortion free face design maintains face flatness throughout operating range
- Extended travel bellows core allows for extreme linear shaft growth, typical in high temperature pumping
- Flexible graphite gasketing in lieu of elastomers improves temperature and chemical compatibility
- Provisions for anti-coking steam quench included as standard

Other Configurations

BXHHS

- API 682 Arrangement 1 Type C seal alternate configuration
- Shorter version designed to fit pumping equipment with axial length restrictions and when dual seals are required

BXHHS/GSDH

High temperature containment seals

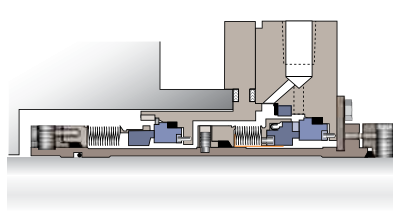

Equipment Type

- High-temperature pumps, including API 610

Operating Parameters

Pressure up to 20.7 bar (300 psi)
 Temperature -73 to 427°C (-100 to 800°F)
 Speed up to 19.8 m/s (57 fps)
 Shaft Sizes 28.2 to 128.9 mm
 (1.110 to 5.073 inch)

Features

- API 682 Arrangement 2 Type C seal with dry running containment seal
- Alloy 718 heat-treated bellows
- Steam buffer gas mitigates product coking in the buffer area and reduces heat loss from the product
- Vibration dampening features stabilize the containment seal bellows
- Containment seal runs dry for long periods and is ready to take over if the primary seal leaks
- Piped with a Plan 75 and/or 76 containment system, very low product emissions are provided

Other Configurations

BXHHS/BXHHS

- API 682 Arrangement 2 Type C seal for use with an unpressurized liquid buffer fluid

BXHHSB/BXHHS

- API 682 Arrangement 3 Type C dual face to back configuration pressurized barrier applications

BRC

Single balanced rotating metal bellows seals

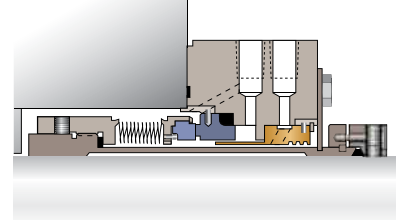

Equipment Type

- High-temperature pumps, including API 610

Operating Parameters

Pressure up to 20.7 bar (300 psi)
 Temperature -73 to 427°C (-100 to 800°F)
 Speed up to 23 m/s (75 fps)
 Shaft Sizes 28.2 to 150 mm
 (1.110 to 5.906 inch)

Features

- API 682 Arrangement 1 Type C seal alternate configuration
- Most rugged bellows available featuring 0.25 - 0.30 mm (10 - 12 mils) thick convolutions
- Alloy 718 heat-treated bellows and end adapters provide the highest resistance to stress corrosion cracking
- Applications include: cryogenic, corrosive, hydrocarbons, and heat transfer fluids
- Canned face design eliminates shrink fit distortions
- Standard threaded-on bellows adapter

Other Configurations

BRCH

- Utilizes a bolted bellows adapter for convenient repairs when necessary

BRCS

- Shorter version designed to fit pumping equipment with axial length restrictions and when dual seals are required

Reference FSD142

Mixer Seals

In chemical, pharmaceutical, food and oil refinery process plants, diverse systems are employed for agitating, blending and mixing products. Mixers, agitators, reactors, filters, dryers, and other specialty equipment require low maintenance operation and safety, both to protect the environment and the workplace. The mechanical seal design must provide excellent performance in the application, allowing for axial and radial shaft movements.

Flowserve is focused specifically to provide the best mixer sealing solutions:

- Liquid lubricated, dry contacting or noncontacting face technology
- Ability to handle significant radial and axial shaft run-outs
- Cartridge designs with and without a bearing
- Top, bottom and side entry seals
- Modular designs allowing easy part replacement

- Accommodation for sanitary gland/debris catcher for applications requiring steam cleaning
- Reverse pressure capability and emergency sealing solutions option
- Cooling flange option
- Numerous pre-engineered designs fit popular OEM equipment
- Ability to design and engineer to customer and OEM specifications
- Designs engineered according to ISO and international standards
- Materials selected for corrosion resistance and long seal life
- Split mixer seal designs allow easy installation without dismantling equipment
- Sterilizable designs available
- Seal support systems to enhance reliability
- Knowledgeable and experienced mixer seal team support



MW-200	26
ML-200	26
MD-200	26
Mixerpac 2568	27
Mixerpac 581	27
Mixerpac 589	27
VRA	28
MSS	28
ST	28



MW-200

Top entry, wet mixer seals

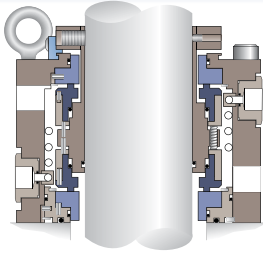

Equipment Type

- Mixers, agitators, filters, filter dryers

Operating Parameters

Pressure	vacuum to 35 bar (500 psi)
Temperature	-40 to 200°C (390°F)
Speed	up to 4 m/s (13 fps)
Shaft Sizes	40 to 220 mm (1.575 to 9.000 inch)

Features

- Liquid lubricated seal
- Product side seal has reverse pressure capability
- Balanced dual pressurized seal
- Cooling coil options for higher temperatures available
- Cooling flange for higher temperatures up to 300°C (570°F) available
- Available with or without bearing
- Designed for steel or glass lined vessels
- Optional materials compliant with FDA CFR 21, USP Class VI, ADI Free Components and similar specifications

Other Configurations

MW-200 DIN

- Dimensions and flange connections to DIN for steel or glass lined flanges
- With or without bearing

Reference FSD104

ML-200

Top entry, lift-off mixer seals

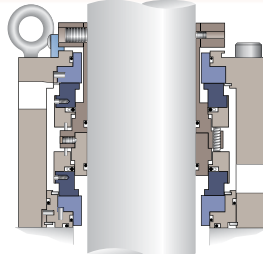

Equipment Type

- Mixers, agitators, filters, filter dryers

Operating Parameters

Pressure	vacuum to 6.7 bar (100 psi)
Temperature	-40 to 200°C (390°F)
Speed	up to 10 m/s (33 fps)
Shaft Sizes	40 to 220 mm (1.575 to 9.000 inch)

Features

- Noncontacting, lift-off gas barrier seal
- Advanced lift-off technology avoids wear from seal face contact
- Barrier leakage does not affect product quality
- Low drag design for the dynamic O-ring (no hang-up)
- Operates with a simple gas barrier support system
- Optional with or without bearing
- Cooling flange for higher temperatures up to 300°C (570°F) available
- Sanitary gland option for sterilization purposes
- Available for steel or glass lined vessels
- Optional materials compliant with FDA CFR 21, USP Class VI, ADI Free Components and similar specifications

Other Configurations

ML-200 DIN

- Dimensions and flange connections to DIN for steel or glass lined flanges
- With or without bearing

Reference FSD104

MD-200

Top entry, dry contacting mixer seals

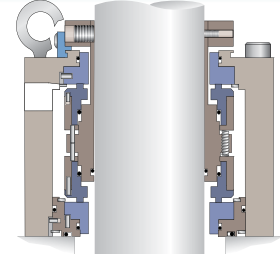

Equipment Type

- Mixers, agitators, blowers, fans

Operating Parameters

Pressure	vacuum to 6.7 bar (100 psi)
Temperature	-40 to 150°C (300°F)
Speed	up to 1.5 m/s (5 fps)
Shaft Sizes	40 to 220 mm (1.575 to 9.000 inch)

Features

- Contacting gas barrier seal
- Product side seal has reverse pressure capability
- Dry-running for minimized product contamination from barrier fluid
- Features self-lubricating faces
- Cooling flange for higher temperatures up to 200°C (390°F) available
- Available with or without bearing
- Optional leakage collector at inboard seal
- Available for steel or glass lined vessels
- Optional materials compliant with FDA CFR 21, USP Class VI, ADI Free Components and similar specifications

Other Configurations

MD-200 DIN

- Dimensions and flange connections to DIN for steel or glass lined flanges

MD-100

- Single dry running seal

Reference FSD104

Mixerpac 2568

Top entry mixer seals for sterile applications

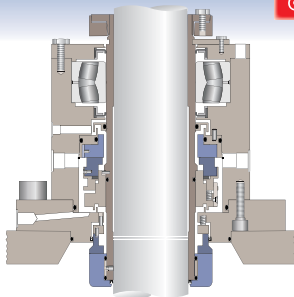

Equipment Type

- Mixers, reactors, filters, filter dryers

Operating Parameters

Pressure	vacuum to 10 bar (145 psi)
Temperature	-40 to 200°C (390°F)
Speed	up to 10 m/s (33 fps)
Shaft Sizes	40 to 220 mm (1.575 to 9.000 inch)

Features

- Noncontacting, lift-off gas barrier seal
- Modular cartridge design
- Balanced dual pressurized design
- Advanced lift-off technology avoids wear, resulting from seal face contact
- Operates with a gas barrier support system
- Barrier leakage does not affect product side
- Construction with few gaps and crevices
- Easy to clean / sterilize
- Optional materials compliant with FDA CFR 21, USP Class VI, ADI Free Components and similar specifications

Other Configurations

Mixerpac 2570

- Lift-off seal for glass lined vessels
- All wetted parts metal free

Reference FSD133

Mixerpac 581

Top and side entry for high pressure applications

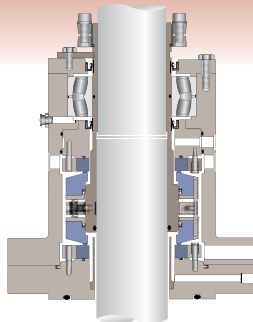

Equipment Type

- Mixers, reactors

Operating Parameters

Pressure	vacuum to 250 bar (3600 psi)
Temperature	-40 to 200°C (390°F)
Speed	up to 4 m/s (13 fps)
Shaft Sizes	40 to 220 mm (1.575 to 9.000 inch)

Features

- Modular cartridge design with bearing
- Liquid lubricated seal
- Balanced dual pressurized design
- Seal faces optimized through FEA
- Cooling flange for higher temperatures up to 300°C (570°F) available
- Optional with or without leakage collector
- Optional materials compliant with FDA CFR 21, USP Class VI, ADI Free Components and similar specifications

Reference FSD127

Mixerpac 589

Horizontal entry mixer seals for large shaft movements

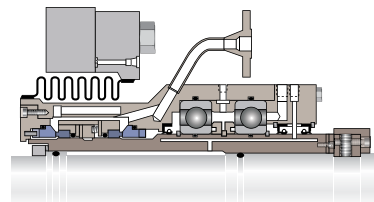

Equipment Type

- Reactors, dryers

Operating Parameters

Pressure	vacuum to 40 bar (580 psi)
Temperature	-40 to 200°C (390°F)
Speed	up to 4 m/s (13 fps)
Shaft Sizes	40 to 400 mm (1.575 to 15.750 inch)

Features

- Cartridge design with bearing
- Liquid lubricated seal
- High pressure formed metal bellows compensates to follow axial movements up to +/- 40 mm (1.575 inch)
- Balanced dual pressurized design
- Perpendicularity of housing to the rotating shaft guided by bearings installed in the seal cartridge

Other Configurations

Mixerpac 588

- Top and side entry mixer seals for sterile applications
- Bioreactors and others
- Highly viscous or pulverized products
- Optional materials compliant with FDA CFR 21, USP Class VI, ADI Free Components and similar specifications

Reference FSD127

VRA

Top entry, dry running single mixer seals

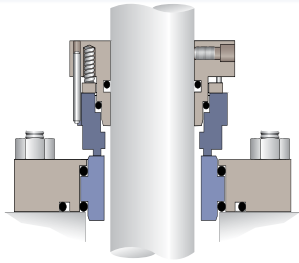

Equipment Type

- Mixers, agitators

Operating Parameters

Pressure	up to 6 bar (90 psi)
Temperature	-18 to 150°C (0 to 300°F)
Speed	up to 1.5 m/s (5 fps)
Shaft Sizes	40 to 220 mm (1.500 to 9.000 inch)

Features

- Dry running contacting seal
- Single design
- No buffer fluid system needed
- Handles eccentricity of 3.8 mm (0.150 inch) TIR
- Other sizes and operating limits upon request
- Available with or without bearing
- Optional cartridge design
- Sanitary gland for sterilization purposes
- Optional materials compliant with FDA CFR 21, USP Class VI, ADI Free Components and similar specifications

Other Configurations

VRA-C

- No product wetted metal parts

Reference FSD167

MSS

Top entry, split mixer seals

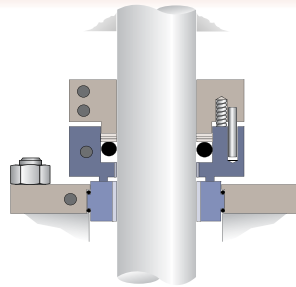

Equipment Type

- Mixers, agitators

Operating Parameters

Pressure	up to 6 bar (90 psi)
Temperature	-18 to 150°C (0 to 300°F)
Speed	up to 1.5 m/s (5 fps)
Shaft Sizes	40 to 220 mm (1.500 to 9.000 inch)

Features

- Dry running contacting design
- Outside mounted split seal
- Single balanced design
- No wetted metal parts
- Installation without machine disassembly
- Other sizes and operating limits upon request
- Optional materials compliant with FDA CFR 21, USP Class VI, ADI Free Components and similar specifications

Reference FSD162

ST

Bottom entry mixer seals for sterile applications

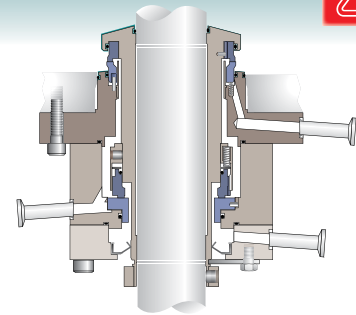

Equipment Type

- Mixers, bioreactors

Operating Parameters

Pressure	vacuum to 6 bar (90 psi)
Temperature	-40 to 200°C (390°F)
Speed	up to 4 m/s (13 fps)
Shaft Sizes	40 to 220 mm (1.500 to 9.000 inch)

Features

- Liquid lubricated seal
- Dual design
- For sterile vessels
- For CIP and SIP use
- Drainable
- Minimum crevices
- Clean product side
- Optional with or without bearing
- Optional materials compliant with FDA CFR 21, USP Class VI, ADI Free Components and similar specifications

Other Configurations

Bottom entry: Mixerpac 585/586

- Bottom entry mixer seals without a bearing (585) and with a bearing (586)
- Slurry seal design
- Flush available

Reference FTA147

Compressor Seals

Flowserve has the technical expertise to provide superior products and solutions for your compressor operations and sealing requirements.

We are the leading-edge service provider for dry gas seal retrofits, high end compressor seal troubleshooting, seal support engineering and world class gas conditioning systems.

A convergence of technologies and experience from the trusted names in gas seal and system manufacture, application, and retrofitting, our heritage Durametallic, Pacific Wietz, Revolve Technologies, and BW Seals brands present more opportunities for success than ever before.

Features of our Gaspac dry gas seal line include innovative solutions to secondary sealing, reverse rotation, reverse pressurization, and centering of rotating components. Seals feature our Precision Face Topography with a choice of unidirectional Advanced Pattern Groove (APG) or bidirectional T-Groove, plus a choice of dynamic sealing options, all within a universal housing.

The acknowledged leader in fluid sealing

Flowserve has the best of existing technology in one comprehensive product line with configurations tailored to each application.

- Gaspac® dry gas seals
- Circpac™ carbon ring seals
- Gas conditioning systems
- Turbopac™ oil seals

Value added services

- Compressor gas seal retrofit services
- ReadySeal™ compressor seal maintenance and inventory program
- Global repair and testing service facilities in
 - Dortmund, Germany
 - Kalamazoo, USA
 - Macaé, Brazil
 - Dubai, UAE
 - Singapore



Gaspac T	30
Gaspac L	30
Gaspac D	30
Gaspac S	31
Circpac CB	31
Circpac LO	31
Circpac HP	32
Turbopac 378	32
Supplypac™	32
Cleanpac™ D	33
Cleanpac™ F	33
Cleanpac™ DL	33
Ampliflow™	34
Drypac™	34
N2 Genpac™	34

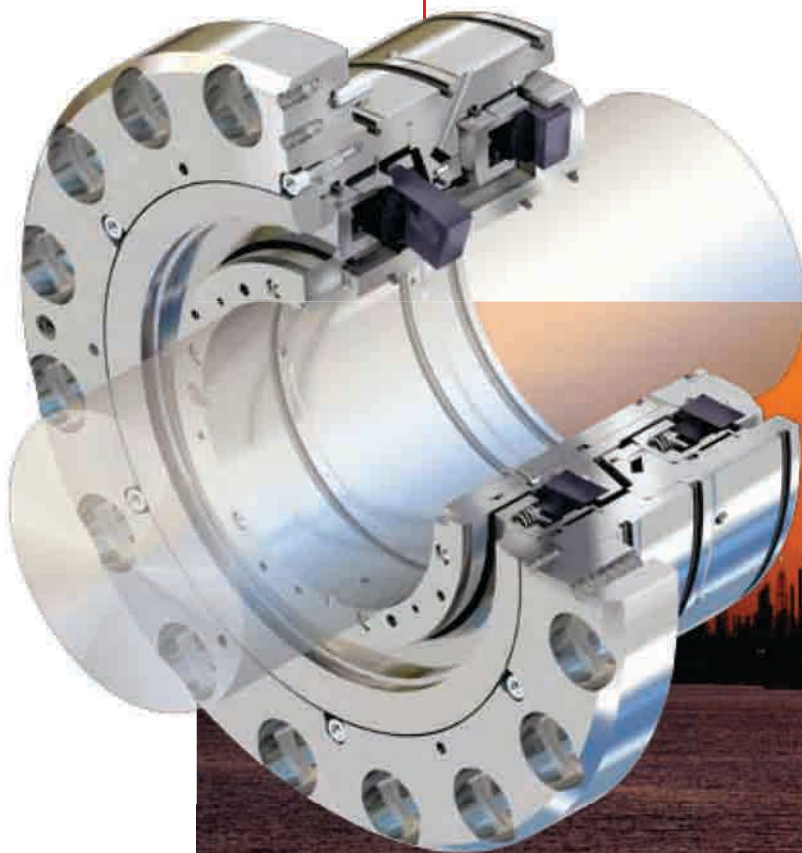

Gaspac T

Tandem compressor seals

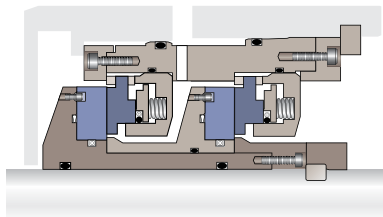
**Equipment Type**

- Compressors

Operating Parameters

Pressure up to 425 bar (6160 psi)

Temperature -100 to 230°C
(-150 to 450°F)

Speed 1 to 250 m/s (3 to 820 fps)

Shaft Sizes 40 to 360 mm
(1.500 to 14.125 inch)**Features**

- Tandem arrangement cartridge seal
- Both inboard and outboard seals have full product pressure capability
- Outboard seal normally operates under low pressure. In the event of an inboard seal failure, the outboard seal acts as an installed spare
- Process gas has controlled leakage across both sets of seal faces
- Choice between T-Groove face geometry for bidirectional rotation or Advanced Pattern Groove for unidirectional rotation
- Seal faces are noncontacting from slow roll up to the highest speeds
- Spring energized O-ring provides low drag for excellent seal face tracking
- Optional PTFE dynamic sealing element extends the temperature range and chemical resistance
- Standardized inboard and outboard seal parts for easy interchangeability
- Higher pressures and larger sizes available on request

Reference FSD113

Gaspac L

Tandem seal with interstage labyrinth

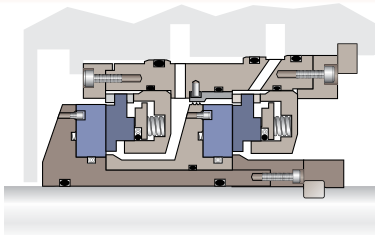
**Equipment Type**

- Compressors

Operating Parameters

Pressure up to 425 bar (6160 psi)

Temperature -100 to 230°C
(-150 to 450°F)

Speed 1 to 250 m/s (3 to 820 fps)

Shaft Sizes 40 to 360 mm
(1.500 to 14.125 inch)**Features**

- Interstage labyrinth keeps process gas from migrating to outboard seal faces
- Eliminate process leakage gas to atmosphere with interstage purge
- Both inboard and outboard seals have full product pressure capability
- Outboard seal acts as an installed spare with full pressure capability
- Choice between T-Groove face geometry for bidirectional rotation or Advanced Pattern Groove for unidirectional rotation
- Seal faces are noncontacting from slow roll up to the highest speeds
- Spring energized O-ring provides low drag for excellent seal face tracking
- Optional PTFE dynamic sealing element extends the temperature range and chemical resistance
- Standardized inboard and outboard seal parts for easy interchangeability
- Higher pressures and larger sizes available on request

Reference FSD113

Gaspac D

Double compressor seals

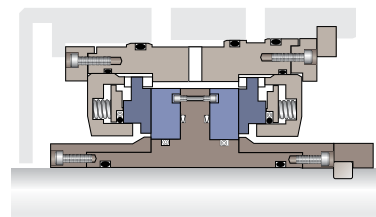
**Equipment Type**

- Compressors

Operating Parameters

Pressure up to 60 bar (870 psi)

Temperature -100 to 200°C
(-150 to 400°F)

Speed 1 to 140 m/s (3 to 460 fps)

Shaft Sizes 40 to 360 mm
(1.500 to 14.125 inch)**Features**

- Dual pressurized opposed arrangement seal configuration
- Inboard and outboard seals run at barrier pressure set higher than the process pressure
- For toxic and/or flammable process gases where zero process emissions are required
- For process gas contaminated with particles
- For very low pressure applications where a tandem seal can not be used
- Choice between T-Groove face geometry for bidirectional rotation or Advanced Pattern Groove for unidirectional rotation
- Seal faces are noncontacting from slow roll up to the highest speeds
- Spring energized O-ring provides low drag for excellent seal face tracking
- Optional PTFE dynamic sealing element extends the temperature range and chemical resistance
- Standardized inboard and outboard seal parts for easy interchangeability
- Higher pressures and larger sizes available on request

Reference FSD113

Gaspac S

Single compressor seals

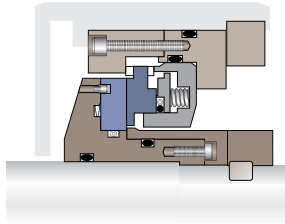

Equipment Type

- Compressors

Operating Parameters

Pressure up to 250 bar (3600 psi)

Temperature -100 to 230°C
(-150 to 450°F)

Speed 1 to 250 m/s (3 to 820 fps)

Shaft Sizes 40 to 360 mm
(1.500 to 14.125 inch)

Features

- Single cartridge seal with controlled process gas leakage to the atmosphere
- For clean applications where the gas sealed is neither flammable nor harmful to the atmosphere
- Circpac or labyrinth seals may be integrated to reduce the amount of process leakage
- Choice between T-Groove face geometry for bidirectional rotation or Advanced Pattern Groove for unidirectional rotation
- Seal faces are noncontacting from slow roll up to the highest speeds
- Spring energized O-ring provides low drag for excellent seal face tracking
- Optional PTFE dynamic sealing element extends the temperature range and chemical resistance
- Higher pressures and larger sizes available on request

Reference FSD113

Circpac CB

Carbon ring seals

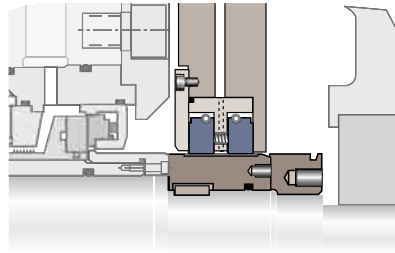

Equipment Type

- Compressors

Operating Parameters

Pressure up to 5 bar (70 psi)

Temperature -40 to 80°C (180°F)

Speed up to 140 m/s (460 fps)

Shaft Sizes 40 to 360 mm
(1.500 to 14.125 inch)

Features

- Carbon ring seals for continuous noncontacting operation and no wear
- Helps protect the Gaspac seal from bearing oil mist
- Applied to the front of a Gaspac seal, works to separate process gas from the Gaspac seal
- Designed to prevent process gas leakage into the bearing oil
- Bidirectional design handles reverse rotation which means less spare parts inventory
- No dewpoint limitation for separation gas
- High operational safety and reliability

Reference FSD113

Circpac LO

Carbon ring seals

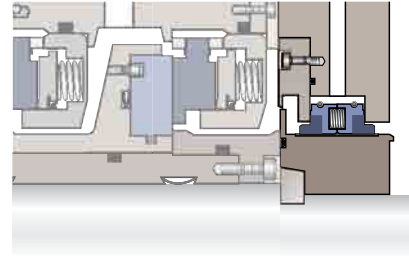

Equipment Type

- Compressors

Operating Parameters

Pressure up to 5 bar (70 psi)

Temperature -40 to 140°C (-40 to 280°F)

Speed up to 140 m/s (460 fps)

Shaft Sizes 40 to 360 mm
(1.500 to 14.125 inch)

Features

- Balanced floating carbon ring design
- Bidirectional T-Groove technology on the inside diameter provides noncontacting operation and no wear
- Helps protect the Gaspac seal from bearing oil mist
- Helps prevent process gas leakage from entering the bearing oil chamber
- Precision mortise joint design provides low joint bypass leakage
- Minimized clearance for low gas consumption
- Same gas consumption under static and dynamic conditions
- No dewpoint limitation for separation gas

Reference FSD113

Circpac HP

Carbon ring seals

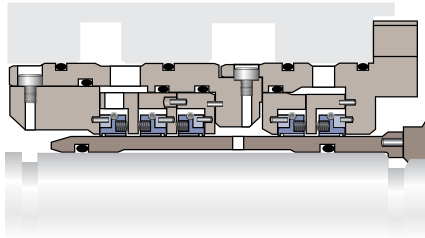
**Equipment Type**

- Compressors

Operating Parameters

Pressure up to 10 bar (145 psi)

Temperature -40 to 180°C (350°F)

Speed up to 90 m/s (300 fps)

Shaft Sizes 25 to 280 mm
(1.000 to 11.000 inch)**Features**

- Carbon ring seals for stand alone operation
- Cost effective sealing solution for low pressure applications where the very low leakage of a conventional gas seal is not required
- Any ring combination can be arranged in a Circpac seal to meet specific application requirements
- Additional features such as labyrinths, face seals, pressure sensing ports and purge/vent/drain ports are available

Reference FSD113

Turbopac 378

Turbo compressor seals

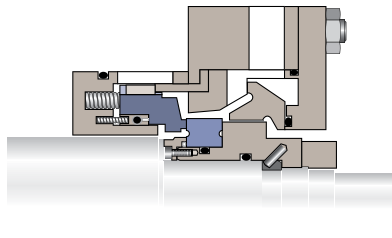
**Equipment Type**

- Compressors

Operating Parameters

Pressure up to 100 bar (1450 psi)

Temperature -40 to 180°C (360°F)

Speed up to 90 m/s (300 fps)

Shaft Sizes 40 to 260 mm
(1.500 to 10.250 inch)**Features**

- Balanced single or dual seal
- Bidirectional seal face technology
- Designed for optimized operational safety and reliability for higher speed and pressure applications
- Non-rotating spring assembly for higher rotational speed
- Reverse pressure capability
- Cartridge design available for easy installation
- Solid stationary face
- Optimized heat transfer
- Handles emergency shut downs
- Available in face to face arrangement

Other Configurations**Turbopac 2100**

- Dual pressurized seal for high pressure applications up to 100 m/s (330 fps) and 300 bar (4350 psi)

Reference FSD113

Supplypac™

Dry gas seal support system

**Equipment Type**

- Compressors

Operating Parameters

Pressure up to 413.6 bar (6000 psi)

Temperature up to 204°C (400°F)

Features

- Eliminates NDE required with welded systems
- Enhanced safety over welded systems
- Shortened delivery cycles through reduction in engineering, manufacturing and assembly time
- Flexible, modular design, key for offshore installations with space limitations
- Accommodates bolt-on seal gas conditioning equipment whether added at the factory or in the field
- Allows for individual component packaging and shipping to accommodate field assembly

Design Specifications

- Meets API 614 design criteria and is ASME B31.3 certified
- Utilizes proprietary Flowserve flanges
- Effective bore comparable to 1 inch XXS pipe
- Flow paths are scalable for lower pressure, larger bore, and higher flow rates
- Materials: 316/316L stainless steel, monel, and others as required
- Gaskets: FKM, FFKM, PTFE, RTJ, spiral wound
- Industry standard material certification available for components

Reference FSD113

Cleanpac™ D

Liquid removal system

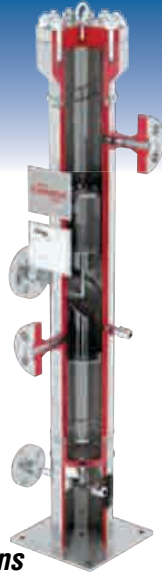

Equipment Type

- Compressors

Design Specifications

Type of filtration	Bulk liquid removal
Bulk liquid removal	Plate / mesh pad removal
Efficiency	10µ particles @ 99%
Maximum flow rate	622 ALM (22 ACFM)
Lower chamber liquid holding capacity	5 liter (1.3 gallon)
Maximum design pressure	350 bar (5076 psi)
Maximum design temperature	204°C (400°F)

Features

- Largest single purpose liquid removal vessel in the Flowserve inventory
- Incorporates dual stage technology to insure maximum efficiency
- Mesh pad removes large particles (>10 µm) and coalesces fine mists and liquids that are entrained within the gas stream

Other Configurations

Cleanpac DC

- Employs all of the liquid removal capabilities of the Cleanpac D in a highly compact design

Reference FSD113

Cleanpac™ F

Pre-filter



Equipment Type

- Compressors

Design Specifications

Type of filtration	Coalescing
Bulk liquid removal	Vane pack
Efficiency	0.3µ Absolute
Maximum flow rate	622 ALM (22 ACFM)
Lower chamber liquid holding capacity	3.5 liter (0.9 gallon)
Upper chamber liquid holding capacity	2.6 liter (0.68 gallon)
Maximum design pressure	350 bar (5076 psi)
Maximum design temperature	204°C (400°F)

Features

- Dual stage liquid knockout and fine particulate filter
- Benefits of a pre-filter liquid removal system and a final coalescing filter in one complete package
- Larger coalescing element allows for extended operational periods between change-outs or accommodates extremely high levels of particulate contamination

Reference FSD113

Cleanpac™ DL

Single and dual coalescing filters



Equipment Type

- Compressors

Design Specifications

Type of filtration	Coalescing
Efficiency	0.3µ Absolute
Maximum flow rate	368 ALM (13 ACFM)
Lower chamber liquid holding capacity	0.213 liter (0.05 gallon)
Maximum design pressure	350 bar (5076 psi)
Maximum design temperature	204°C (400 °F)

Features

- A general service coalescing filter assembly designed to protect dry gas seals and other sensitive equipment from particles and fine liquid mists
- The simple design is focused on the safety of continuous flow and ease of use
- Can be configured in single, dual arrangements (with or without transfer valve) and in a double block and bleed arrangement
- With the addition of actuated transfer valves the versatility of the Cleanpac DL is expanded to include utilization in unmanned stations
- The typical application of the Cleanpac DL is a combination of the transfer valve and two single housings, creating an assembly that is reliable and effective

Reference FSD113

Ampliflow™

Ensures adequate supply of clean, filtered gas

**Equipment Type**

- Compressors

Operating Parameters

Pressure up to 345 bar (5000 psi)

Temperature up to 200°C (400°F)

Design Specifications

Materials of construction Marine grade aluminum or stainless steel

End connections NPT, flanged or butt weld

Booster drive media Air, N₂ or clean process gas

Features

- Helps ensure that an adequate supply of clean, filtered gas is provided to the seals during periods of low differential across the compressor
- Can be configured as a portable unit, a stand alone panel or integrated with a Flowserve dry gas seal control panel or a Flowserve filter gas conditioning panel

Reference FSD113

Drypac™

Gas dryer

**Equipment Type**

- Compressors

Features

- Reduce the potential of liquid formation between the seal faces by lowering the dew point of the gas and raising the temperature of the seal supply gas at least 20°C (36°F) above the dew point as recommended by API standards
- Helps increase the MTBF of dry gas seals when the dew point of the gas is a potential issue
- Simplified installation, operation and maintenance
- Can be integrated with an existing gas seal control panel

Reference FSD113

N2 Genpac™

Nitrogen generator

**Equipment Type**

- Compressors

Features

- Generates nitrogen gas from compressed air in hazardous conditions or remote locations
- Each unit provides dual parallel filtration for nitrogen flow without interruption
- Designed as an independent system and can also be integrated with the Flowserve Dry Gas Seal Panel or Flowserve Cleanpac™ and Drypac™ gas conditioning system
- Nitrogen purities between 97% and 99%
- Oxygen analyzer available
- Monitored filter performance with differential pressure indicating transmitters and inlet/outlet pressure gauges
- Designed for ease of maintenance
- Stainless steel and aluminum designs

Reference FSD113

Slurry Seals

Flowserve offers a complete range of sealing products for all types of slurries in mining and ore processing, wastewater, flue gas desulphurization, and general dirty services. Our rugged and robust slurry seals are engineered to perform and built to last.

Whether you have a slurry liquid that requires economic value, standard application or extreme service seals, Flowserve is uniquely positioned to provide the following solutions:

- The broadest performance window for flushless applications
- No flush required up to MOH 9 slurry particle hardness

- Solids content up to 60% by weight
- Smooth geometries and non-wetted springs resist clogging
- Economical designs for low solids applications
- Modular components that promote field repair capability
- Engineered assemblies to fit common slurry pumps
- Knowledgeable and experienced slurry team to support installation, commissioning and unique job site applications
- Enhance seal operation and extend plant reliability with accessories: Synthetic Lubrication Device (SLD), Quench Containment Device (QCD), and Erosion Protection Device (EPD)



SLC	36
SLM-6000	36
SLM-6200	36
RIS	37
Allpac	37



SLC

Heavy duty cartridge pusher seals

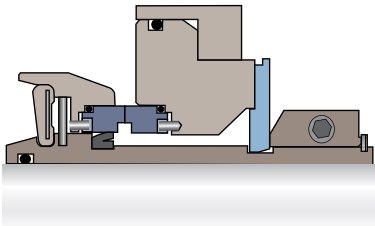
**Equipment Type**

- Slurry pumps

Operating Parameters

Pressure	up to 20.6 bar (300 psi)
Temperature	-18 to 110°C (0 to 230°F)
Speed	up to 15 m/s (50 fps)
Shaft Sizes	32 to 220 mm (1.250 to 8.661 inch)

Features

- Designed to handle solids up to 60% by weight
- Non-clogging cone spring design has no dynamic O-ring to hang-up
- Designed to operate without flush to reduce operating costs and eliminate product dilution
- Line on line hydraulically balanced faces for excellent seal reliability
- Available in High Chrome Iron as standard material selection
- Quench Containment Device (QCD) available if quench is requested
- Synthetic Lubrication Device (SLD) available to extend flushless seal life in harsh slurry applications
- Optional Erosion Protection Device (EPD) reduces gland erosion

Reference FSD120

SLM-6000

Single balanced cartridge pusher seals

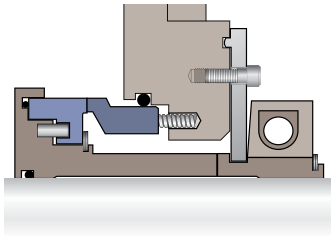
**Equipment Type**

- Slurry pumps

Operating Parameters

Pressure	up to 17.2 bar (250 psi)
Temperature	-40 to 135°C (275°F)
Speed	up to 23 m/s (75 fps)
Shaft Sizes	50 to 235 mm (2.000 to 9.250 inch)

Features

- Designed to handle solids up to 20% by weight
- Single slurry seal
- Standardized modular design
- Clamp collar drive
- Line on line hydraulically balanced faces for excellent seal reliability
- Springs are located outside the process
- Wet end and dry end installation available

Other Configurations

- Quench Containment Device (QCD) available if quench is requested
- Synthetic Lubrication Device (SLD) available to extend flushless seal life in harsh slurry applications
- Optional Erosion Protection Device (EPD) reduces gland erosion

Reference FSD166

SLM-6200

Dual balanced cartridge pusher seals

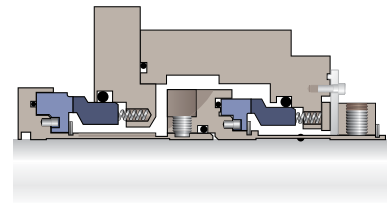
**Equipment Type**

- Slurry pumps

Operating Parameters

Pressure	up to 17.2 bar (250 psi)
Temperature	-40 to 149°C (300°F)
Speed	up to 23 m/s (75 fps)
Shaft Sizes	50 to 235 mm (2.000 to 9.250 inch)

Features

- Designed to handle solids up to 60% by weight
- Dual pressurized slurry seal fully isolates process from the atmosphere
- Eliminates slurry abrasion on seal faces
- Standardized modular design
- Clamp collar drive
- Line on line hydraulically balanced faces for excellent seal reliability
- Wet end and dry end installation available
- Optional Erosion Protection Device (EPD) reduces gland erosion

Reference FSD166

RIS

Rubber energized slurry seals

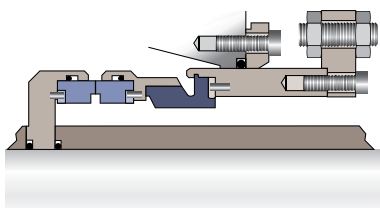
**Equipment Type**

- Slurry pumps

Operating Parameters

Pressure	up to 10.3 bar (150 psi)
Temperature	-4 to 110°C (25 to 230°F)
Speed	up to 11 m/s (36 fps)
Shaft Sizes	32 to 235 mm (1.250 to 9.250 inch)

Features

- Designed to handle solids up to 50% by weight
- Non-clogging elastomer spring design has no dynamic O-ring to hang up
- External adjustment feature compensates for seal face wear and pump misalignment
- Designed to operate without flush to reduce operating costs and eliminate product dilution
- Excellent performance experience in flue gas desulphurization (FGD)

Reference FSD151

Allpac

General duty pusher seals

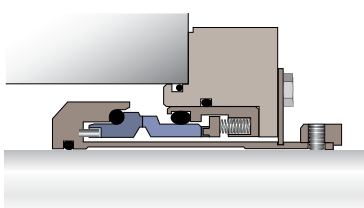
**Equipment Type**

- ISO pumps

Operating Parameters

Pressure	up to 50 bar (725 psi)
Temperature	-40 to 220°C (430°F)
Speed	up to 50 m/s (164 fps)
Shaft Sizes	20 to 300 mm (0.750 to 11.750 inch)

Features

- Springs outside the product avoid clogging
- Faces are made from silicon carbide
- Clean component design
- Large clearances between seal and shaft sleeve
- Robust construction
- Metal free design optional
- Single and dual seal cartridge designs available
- Single spring and multi spring designs

Reference FSD129

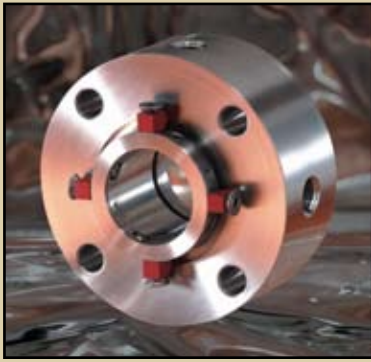

GF-200	39
GX-200	39
GSL	39
GSDH	40
GTSP	40

Gas Barrier and Containment Seals

Running a liquid seal dry is commonly one of the quickest ways to shorten its life. Mechanical seals can, however, be designed to operate successfully without a liquid fluid film. Gas barrier seals have noncontacting seal faces that lift off during operation independent of what's happening in the seal chamber; wet or dry. In the case of containment seals, the seal faces are designed to run dry under normal operation and also handle process liquid during upset events.

Gas barrier seals provide users the benefits of zero process emissions, no process contamination by liquid barrier fluid, a simplified support system, and low power consumption. Containment seals running behind wet seals provide proactive safety by directing process vapor leakage to a collection system, minimizing environmental emissions, and by having the ability to take over if the inboard seal fails.

Gas seal technology pioneered in compressor seals is applicable to pumps and other rotating equipment by taking into account the same aerostatic and aerodynamic forces acting on the seal faces. Flowserve's Precision Face Topography is the essential ingredient that establishes a strong and stable gas film. Unidirectional Advanced Pattern Groove (APG), bidirectional wavy face and hydroplan designs are most common in pump seals. Both pusher and metal bellows seals employ the advantages of gas seal technology for a variety of services.

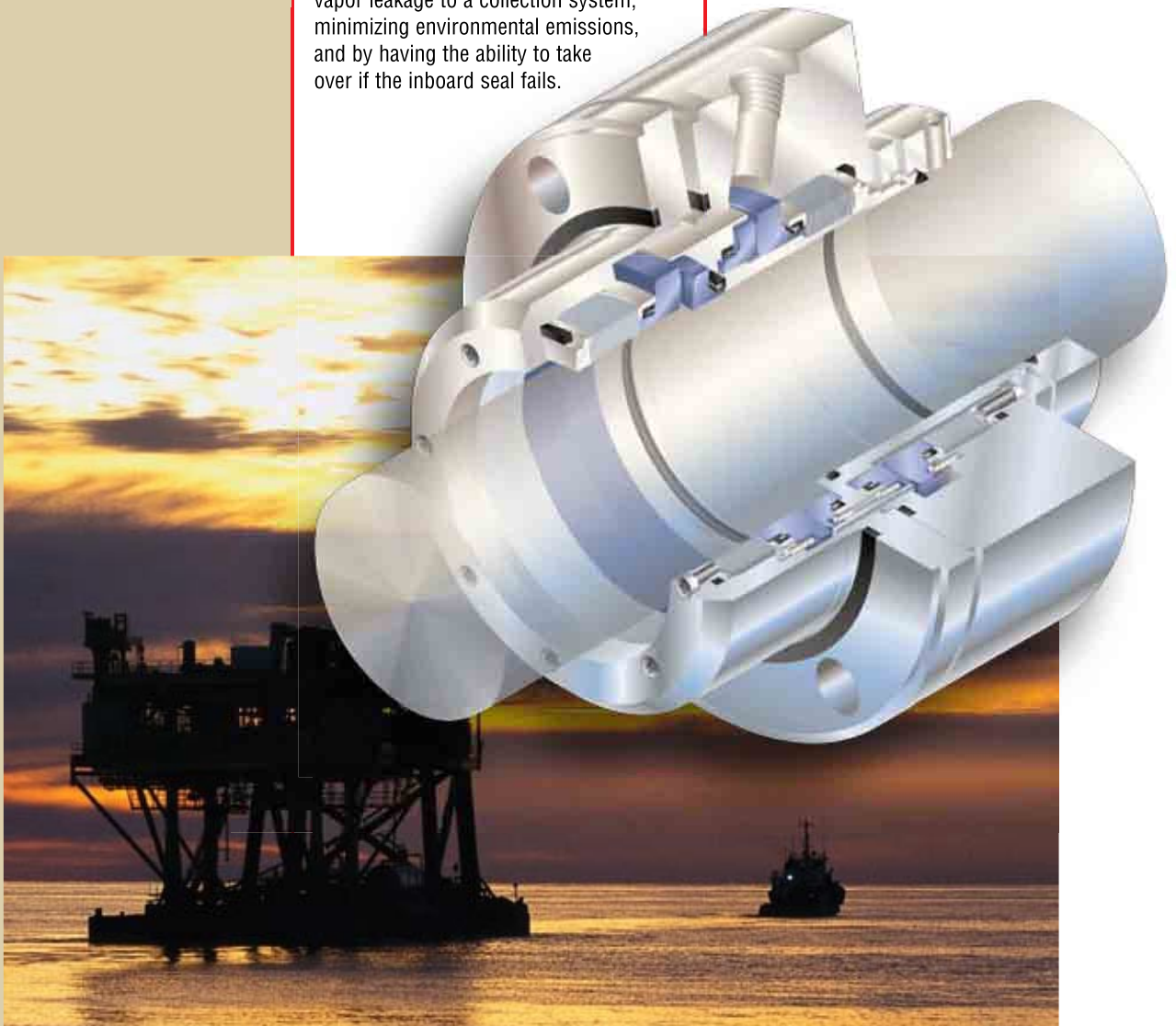

GF-200

Dual noncontacting pusher seals

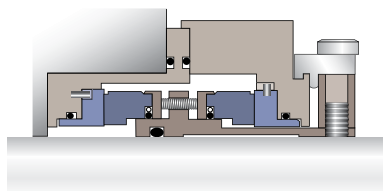

Equipment Type

- General purpose pumps

Operating Parameters

Pressure up to 34.5 bar (500 psi)

Temperature -40 to 260°C (500°F)

Speed 1.3 to 25 m/s (4 to 82 fps)

Shaft Sizes 25.4 to 152 mm
(1.000 to 6.000 inch)

Features

- Dual pressurized pusher seal
- Fits in enlarged bore pumps
- Used in applications where no emissions of hazardous pumped product is tolerated
- Advanced Pattern Groove (APG) provides low speed lift-off, low gas leakage and no face contact, requiring about 25% less power to achieve the same flow and head than with a sealless pump
- Spring energized O-ring design provides consistent loading and low friction drag to reduce seal face hang-up
- Pressurized with an inert gas barrier for lift-off eliminates contamination of pumped product by a buffer fluid
- Tolerates off-design pump operation including vibration, cavitation and dry running
- Simple to install and pressurize

Reference FSD137

GX-200

Dual noncontacting metal bellows seals

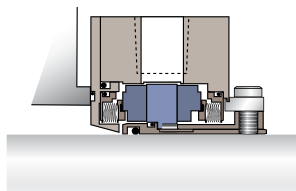

Equipment Type

- General purpose pumps

Operating Parameters

Pressure up to 13.8 bar (200 psi)

Temperature -40 to 260°C (500°F)

Speed 2.5 to 35 m/s (8 to 115 fps)

Shaft Sizes 25.4 to 76.2 mm
(1.000 to 3.000 inch)

Features

- Dual pressurized, externally mounted metal bellows seals
- Used in applications where no emissions of hazardous pumped product is tolerated
- Fits standard or large bore ASME and ISO pumps
- Advanced Pattern Groove provides low speed lift-off, low gas leakage and no face contact
- Alloy C-276 or Alloy 718 metal bellows provide superior seal face tracking responsiveness
- Solids resistant features minimize contamination
- Pressure reversal product containment during upset events
- Tolerates off-design pump operation including vibration, cavitation and dry running

Reference FSD105

GSL

Noncontacting bidirectional containment seals

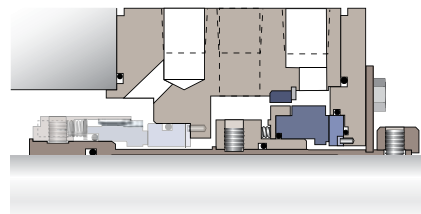

Equipment Type

- API 610 pumps and specialty equipment

Operating Parameters

Pressure up to 41.4 bar (600 psi)

Temperature -40 to 204°C (400°F)

Speed 1.5 to 30.5 m/s (5 to 100 fps)

Shaft Sizes 20.6 to 152 mm
(0.813 to 6.000 inch)

Features

- API 682 Arrangement 2 Type A containment seal
- Dry-running containment seal for flashing hydrocarbon services
- Noncontacting wavy face design provides long-term reliable performance without the need for high maintenance support system
- Capable of near-zero emissions during normal conditions with use of a nitrogen sweep
- Capable of full pressure wet backup sealing in the event of a primary seal failure
- Available for single seal applications in gas services such as vertical sump pumps or on specialty equipment

Other Configurations

GSD

- Contacting containment seal designed for conversion of existing wet running outboard seals

Reference FSD143

GSDH

High temperature metal bellows containment seals

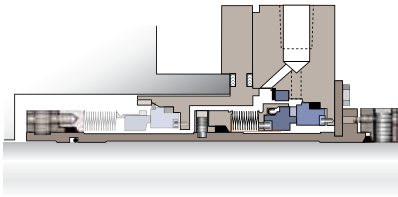

Equipment Type

- API 610 pumps

Operating Parameters

Pressure up to 20.7 bar (300 psi)

Temperature 100 to 427°C
(212 to 800°F)

Speed up to 19.8 m/s (57 fps)

Shaft Sizes 35 to 136.5 mm
(1.375 to 5.125 inch)

Features

- Satisfies all requirements of API 682 Arrangement 2 Type C containment seal
- High temperature dry-running containment seal for hydrocarbon service
- Alloy 718 heat-treated bellows have excellent corrosion resistance
- Steam buffer gas mitigates product coking in the buffer area and reduces heat loss from the product
- Vibration dampening features stabilize the containment seal bellows enabling the seal to run in dry, multiphase, and wet conditions experienced during containment of a primary seal failure
- Hydropad face design provides low heat generation for long-term, contacting seal performance

GTSP

Dual pressurized, high temperature metal bellows gas seals

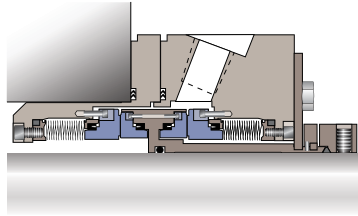

Equipment Type

- API 610 pumps

Operating Parameters

Pressure up to 17.2 bar (250 psi)

Temperature -73 to 427°C
(-100 to 800°F)

Speed 3 to 46 m/s (10 to 150 fps)

Shaft Sizes 47.6 to 104.8 mm
(1.875 to 4.125 inch)

Features

- API 682 Arrangement 3 Type C gas barrier seal
- Suitable for hot oils, gas oils, asphalt, and heat transfer fluids requiring zero emissions
- Alloy 718 heat-treated bellows have excellent corrosion resistance
- Pressurized steam or nitrogen barrier gas establish zero process emissions performance
- Smooth wave topography provides stable seal face separation and improves energy efficiency by reducing drag
- Bidirectional faces allow complete seal interchangeability on double ended pumps

Reference FSD241

OEM & Special Duty Seals

Original Equipment Manufacturers (OEM) are very important to Flowserve. We are committed to develop and supply designs for special equipment and special duty requirements.

Flowserve has developed special mechanical seals to handle the high speed and high pressure conditions for integrally geared API pumps and compressors with excellent performance and reliability. We also offer the GSG gearbox seal with a proven track record for increasing reliability on this type of equipment.

The LS-300 seal is another OEM design suited for low speed high viscosity positive displacement pumps. The PSS III seal is used when assembly of the equipment is difficult and a split seal offers significant benefits. PL-100/200 non-metallic seals are especially suited for non-metallic pumps.

In addition, the Pac-Seal range of single spring seals is available in a wide range of designs in accordance with common industry standards or according to OEM standards. Complete new custom designs can also be developed.



- GTS 42
- GSS 42
- GSG 42
- PL-100 43
- PSS III 43
- LS-300 43
- Circpac MD..... 44
- Pac-Seal 44



GTS

Metal bellows seals for steam turbines

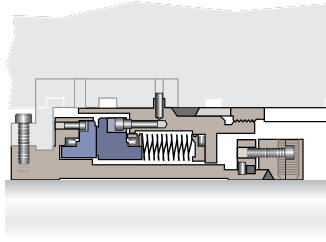

Equipment Type

- Steam turbines

Operating Parameters

Pressure	up to 20.7 bar (300 psi)
Temperature	100 to 343°C (212 to 650°F)
Speed	3 to 46 m/s (10 to 150 fps)
Shaft Sizes	54 to 111.1 mm (2.125 to 4.375 inch)

Features

- Replace carbon rings on steam turbines to significantly reduce steam leakage and improve safety
- Thin film wavy face technology for non-contacting operation on steam
- The wavy face smooth surface is non-clogging and able to recover from upset conditions
- Alloy 718 bellows have excellent corrosion resistance and tolerance to high temperatures
- Internal or external arrangement
- Detachable design for various different turbines
- Designed to handle slow roll operation

Reference FSD107

GSS

Gas lubricated wavy face non-contacting pusher seals

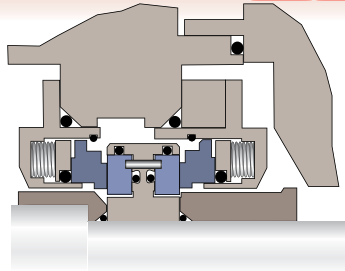

Equipment Type

- High speed, integrally geared pumps and compressors

Operating Parameters

Pressure	up to 86.2 bar (1250 psi)
Temperature	-62 to 204°C (-80 to 400°F)
Speed	1500 to 36,000 rpm
Shaft Sizes	38.1 mm (1.500 inch)

Features

- Precision face topography creates seal face liftoff to eliminate wear
- Noncontacting wavy face gas seal design produces near zero power consumptions
- Configurable as a single seal, a dual seal, and as a dry running containment seal
- In a pressurized arrangement, capable of zero emissions in hydrocarbon applications
- Specifically designed for high speed, integrally geared equipment

Other Configurations

GLS

- Liquid service design with contacting seal faces
- Configurable as a single seal, a dual seal, and with a GSS seal as a containment seal

Reference FSD102

GSG

High speed gearbox seals

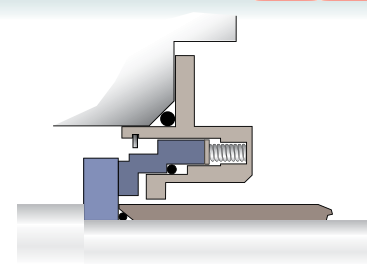

Equipment Type

- High speed, integrally geared pumps and compressors

Operating Parameters

Pressure	up to 17.2 bar (250 psi)
Temperature	-40 to 204°C (400°F)
Speed	1500 to 36,000 rpm
Shaft Sizes	38.1 mm (1.500 inch)

Features

- Innovative Hydrodynamic Surface Tension (HST) face topography creates near zero leakage performance
- Designed for high speed, oil-flooded gearbox applications
- Proprietary laser machined wavy face enables high speed operation
- Direct replacement for existing seals without equipment modification
- Seal face materials suitable for frequent starts and stops

Reference FSD102

PL-100

Non-metallic single seals for highly corrosive services

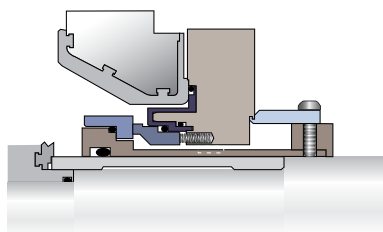

Equipment Type

- Non-metallic or high alloy ASME and ISO pumps

Operating Parameters

Pressure vacuum to 10.3 bar (150 psi)

Temperature -18 to 150°C (0 to 300°F)

Speed up to 23 m/s (60 fps)

Shaft Sizes 35 to 53 mm (1.375 to 2.750 inch)

Features

- Nonmetallic wetted components provide superior chemical resistance
- Special carbon fiber reinforced PTFE sleeve provides excellent mechanical properties to maintain overall seal integrity
- Affordable alternative to high alloy metal seals
- External flush is not required

Other Configurations

PL-200

- Dual non-metallic seal provides zero process emissions when pressurized

PSS III

Split single pusher seals

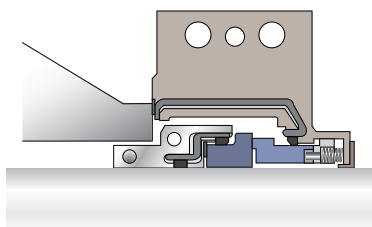

Equipment Type

- Pumps, mixers, agitators

Operating Parameters

Pressure vacuum to 31 bar (450 psi)

Temperature -18 to 121°C (0 to 250°F)

Speed up to 12.7 m/s (42 fps)

Shaft Sizes 38.1 to 152.4 mm (1.500 to 6.000 inch)

Features

- Semi-cartridge split seal
- Used in non-hazardous liquid services in paper mills, waste water treatment facilities, soda ash processing and chemical plants
- Easy to install and repair. No need to completely dismantle the pump
- Non-wetted springs and pins eliminate clogging and seal face hang-up
- Seal faces are pin driven providing positive seal face torque in higher viscosity services
- Positive drive rotor is held firmly in place by set screws to accommodate higher pressures, torque and thrust loads

Reference FSD217

LS-300

Cartridge, multiple dynamic lip seals

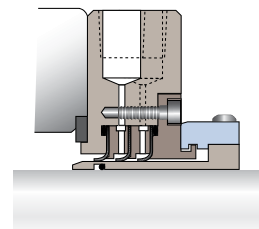

Equipment Type

- Positive displacement, gear, and progressive cavity pumps

Operating Parameters

Pressure up to 10.3 bar (150 psi)

Temperature -53 to 149°C (-65 to 300°F)

Speed up to 3.5 m/s (12 fps)

Shaft Sizes 19.1 to 76.2 mm (0.750 to 3.000 inch)

Features

- Preset cartridge design
- Used in thick, highly viscous, and polymerizing fluids
- Standard viscosity range: 80 to 12,000 cP (400 to 60,000 SSU)
- Designed to run dry without the need for an external flush or lubricating barrier fluid
- Triple lip design effectively seals process from atmosphere
- Easy to install and easy to repair in the field

Reference FSD117

Circpac MD

Segmented circumferential seals

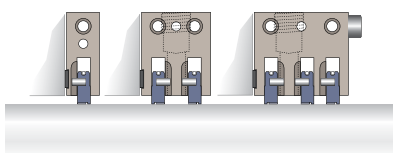
**Equipment Type**

- Fans, blowers, dryers, turbines and centrifuges

Operating Parameters

Pressure vacuum to 6.9 bar (100 psi)

Temperature -40 to 593°C (1100°F)

Speed up to 46 m/s (150 fps)

Shaft Sizes 25.4 to 457 mm
(1.000 to 18.00 inch)**Features**

- Spring energized segmented seal rings used for dry running applications in a variety of specialty equipment
- Fully split design allows installation without dismantling equipment
- Multiple ring configurations provide solutions for reduced leakage, zero process emissions, or emergency backup
- Hydraulically balanced rings with hydrodynamic surface features extend pressure, temperature, and speed limits

Reference FSD195

Pac-Seal

Elastomer bellows seals

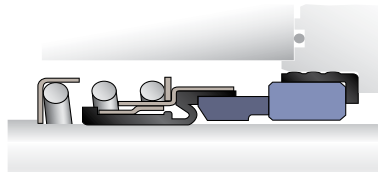
**Equipment Type**

- Pumps

Operating Parameters

Pressure up to 13.8 bar (200 psi)

Temperature -40 to 204°C (400°F)

Speed up to 25 m/s (83 fps)

Shaft Sizes 15.8 mm to 63.5 mm
(0.625 to 2.500 inch)**Features**

- Elastomer bellows seals available with diaphragm elastomer bellows and single springs to meet a wide range of applications
- Unique hex torque drive system provides an improved drive system and longer seal life, allowing the rotary to withstand higher pressures and shaft speeds
- Crimped head rotary unit removes metal-to-seal ring contact and simplifies installation
- Balanced designs are capable of sealing up to 41.5 bar (600 psi)

Reference FSD132

Seal Support Systems

Fluid control over the sealing environment is very important to achieve effective and dependable sealing performance. Seal support systems are used to create that favorable environment around the mechanical seal. The appropriate selection of a seal support system will deliver years of reliable service and operating cost savings.

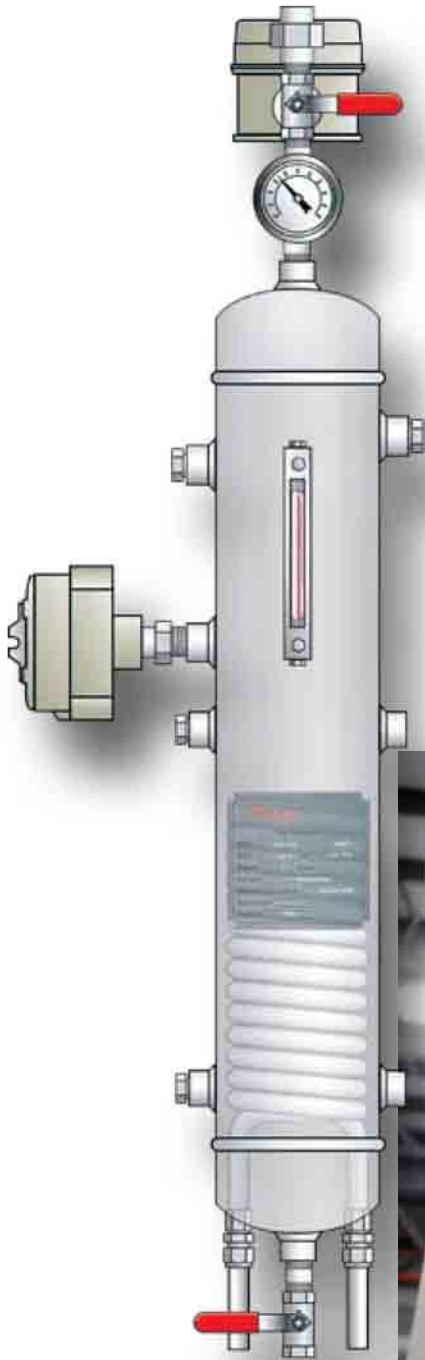

Single seals running in hot environments or with little vapor pressure margin may require extra cooling to remove seal face heat and avoid product vaporization between the seal faces.

Pressurized and unpressurized dual seals require a barrier fluid at the correct pressure, flow, temperature and level to ensure proper functioning of the seals. This requires reservoirs, Plan 53B, Plan 53C systems and pressurizers. Gas barrier seals need gas supply panels for reliable performance.

Flowserve employs a specialized engineering team with years of experience and knowledge designing and selecting seal support systems to suit specific applications, specifications, and unique customer requirements. With a full range of products that meet ASME, API, PED, ISO, and NR13 design criteria, Flowserve addresses the global needs of the oil and gas, petrochemical, chemical, power, pharmaceutical, pulp and paper, and general industries.



- W8 Buffer/Barrier 46
Fluid Reservoirs
- Buffer/Barrier 46
Fluid Reservoirs
- Barrier Systems 47
- Piston Transmitters 47
- Buffer/Barrier Gas Panels . . . 47
- 682 Seal Coolers 48
- LD 682 Seal Coolers 48
- NX Seal Coolers 48
- Airfin Seal Coolers 49
- Circulators 49
- Fill Cart 49



W8 Buffer/Barrier Fluid Reservoirs

ASME (ANSI) general duty



Operating Parameters

Pressure	up to 11 bar (160 psi)
Temperature	up to 65°C (150°F)
Volume	11.4 liter (3 gallon)

Features

- Meets the design criteria Section VIII, ASME B31.3, PED
- Plan 52 and 53A configurations
- Economical light duty reservoir for general service applications
- Instrumentation on each reservoir is according to local standards and can be adapted to suit application and customer requirements
- 304 and 316 stainless steel construction
- Connections are 0.500 inch or 0.750 inch NPT
- Cooling coil is optional
- Industry standard material certification available for components
- For the European market, a similar ASME code design exists with 10 bar design pressure at 16 liter total volume

Other Configurations

CPM

- 2.6 liter (2 gallon) capacity and comes in 304 stainless steel

W2 ASME (ANSI 400)

- 7.6 and 15.1 liter (2 and 4 gallon) capacity for pressure up to 27.6 bar (400 psi)

Reference FSD239

Buffer/Barrier Fluid Reservoirs

API general duty, API 682



Operating Parameters

Pressure	up to 82.3 bar (1200 psi)
Temperature	up to 148°C (300°F)
Volume	20 liter (5 gallon)

Features

- Meets the design criteria of API 682, ASME Section VIII, ASME B31.3, PED
- Plan 52 and 53A configurations
- Construction: Threaded, socket welded, or butt welded
- A wide range of instrumentation can be selected according to local standards and can be adapted to suit application and customer requirements
- 316/316L stainless steel construction
- Connections are 0.750 inch NPT or flange
- Optional cleanable cooling coil
- Industry standard material certification available for components
- Other design codes are available on request

Buffer/Barrier Fluid Reservoirs

ISO general duty



Operating Parameters

Pressure	up to 32 bar (464 psi) on 3 liter (0.8 gallon) and 6 liter (1.6 gallon) up to 20 bar (290 psi) on 10 liter (2.5 gallon)
Temperature	up to 65°C (150°F)
Volume	3 liter (0.8 gallon) 6 liter (1.6 gallon) 10 liter (2.5 gallon)

Features

- Satisfies TRD design code requirements
- Plan 52 and 53A configurations
- Instrumentation on each reservoir is to German standards and can be adapted to suit application and customer requirements
- Connections are G 0.500
- Optional hand pump refills reservoir under pressure

Barrier Systems

Plan 53B



Operating Parameters

Pressure	up to 82.3 bar (1200 psi)
Temperature	up to 148°C (300°F)
Volume	from 20 liter (5 gallon) up to 50 liter (13 gallon)

Features

- Design contains either finned pipe air cooling, a forced draft air cooling, or a water cooler to dissipate seal or pump heat
- Meets the design criteria of API 682, ASME Section VIII, ASME B31.3, PED
- Threaded, socket welded, or butt welded piping
- Carbon steel and 316/316L stainless steel construction
- A wide range of instrumentation can be selected according to local standards and adapted to suit application and customer requirements
- Each seal can be individually monitored
- Various accumulator sizes available to satisfy various operating conditions

Piston Transmitters

Plan 53C



Operating Parameters

Pressure	up to 75.8 bar (1100 psi)
Temperature	up to 148°C (300°F)
Volume	up to 11.4 liter (3 gallon)

Features

- A piston transmitter is a pressure multiplier that generates barrier pressure for dual pressurized liquid seals based on the product pressure
- Used where the pressure in the pump fluctuates or the inboard seal pressure differential must be limited
- Pressure multiplier options: 1:1.1, 1:1.15, and 1:1.2
- Best used for pressures above 3.5 bar (50 psi)
- Can be provided with a cooling coil, external heat exchanger, instrumentation, and refill pump
- Standards: ASME or PED

Buffer/Barrier Gas Panels

Plan 72/74



Operating Parameters

Pressure	up to 34.4 bar (500 psi)
Temperature	up to 93°C (200°F)
Flow	up to 14.2 lpm (30 SCFH)

Features

- Buffer/Barrier gas panels combine flow monitoring and control elements in a self-contained, easy to use unit
- Used for unpressurized and pressurized Flowserve gas seals
- Buffer panels provide unpressurized dual seals with a gaseous quench to flush inner seal leakage to a collection system
- Barrier panels provide dual seals with gaseous barrier pressure set higher than the process pressure. This results in a small amount of gas leakage into the process and zero process leaking to atmosphere
- Meets the design criteria of API 682, ASME B31.3, PED
- Flowserve offers other configurations of control systems ranging from simple standard to complex custom designs

682 Seal Coolers

API 682



Operating Parameters

Cooling coil	275 bar at 371°C (4000 psi at 700°F)
	300 series stainless steel, Alloy 400, duplex 2205
	19 mm OD x 2.41 mm (0.750 inch OD x 0.095 inch)
Cooling area	0.51 m ² (5.5 ft ²)
Shell	13.8 bar at 93°C (200 psi at 200°F)
	300 series stainless steel

Features

- High pressure seal coolers designed in full compliance with API 682
- Fully vent and drain both product and coolant sides
- Easy disassembly for cleaning without damaging coils.
- Standard materials are 300 series stainless steel coil and shell for superior corrosion resistance
- Process fluid flows through the coil while coolant flows through the shell
- Can be provided with ASME U stamp
- Can be configured for series or parallel flow
- Process fluid flows inside the coil, coolant flows outside the coil

Reference FSD106

LD 682 Seal Coolers

API 682



Operating Parameters

Cooling coil	193 bar at 371°C (2800 psi at 700°F)
	316 stainless steel
	19 mm OD x 2.41 mm (0.750 inch OD x 0.095 inch)
Cooling area	0.28 m ² (3.0 ft ²)
Shell	20.7 bar at 93°C (300 psi at 200°F)
	Carbon steel

Features

- Economical seal coolers designed to meet the requirements of API 682
- Fully vent and drain both product and coolant sides
- Easy disassembly for cleaning without damaging coils
- Temperature indicator labels on shell surface measure cooling water temperature
- Process fluid flows through the coil while coolant flows through the shell
- European applications: according to 97/23/EC, PED - Pressure Equipment Directive, this equipment is covered by Article 3.3 (SEP - Sound Engineering Practice)
- Option: a rupture disk prevents over-pressurization of cooling water side

Reference FSD238

NX Seal Coolers

General duty



Operating Parameters

Cooling coil	up 183 bar at 95°C (2650 psi at 200°F)
	304 & 316 stainless steel, Alloy 400, Alloy 600
	12.7 mm OD x 1.65 mm (0.500 inch OD x 0.068 inch)
	15.8 mm OD x 1.65 mm (0.625 inch OD x 0.065)
	19 mm OD x 1.65 mm (0.750 inch OD x 0.065 inch)
Cooling area	0.16 to 0.54 m ² (1.75 to 5.80 ft ²)
Shell	10.3 bar at 93°C (153 psi at 200°F)
	Carbon steel, cast iron

Features

- Light weight high pressure seal coolers for mechanical seal cooling
- Compact design is ideal for installation where space is limited - integral mounting foot and convenient pipe porting arrangement simplify installation
- Process fluid flows through the coil while coolant flows through the shell
- Easy access to tube coil for cleaning; shell and cover are fastened together with one bolt

Reference FSD174

Airfin Seal Coolers

Natural and forced draft



Operating Parameters

Cooling coil up 141 bar at 95°C
(2050 psi at 200°F)
304 stainless steel
15.8 mm OD x 1.65 mm
(0.625 inch OD x 0.065 inch)
Cooling area 2.5 m² (26.8 ft²)

Features

- Air cooled seal coolers reduce temperatures surrounding the mechanical seal without using cooling water
- Airfin Seal Coolers offer substantial savings in flush water purchase and treatment, and they are less susceptible for fouling and require less piping
- Standard cooler types include 625 NC with natural convection and 625 FC with forced air using an electric or pneumatic motor
- Forced air cooler motors are explosion proof Class 1, Gr D, Div 1, 1/3 hp as standard
- Process fluid flows through the coil while air flows across the coil's finned exterior
- Fin materials include carbon steel, aluminum and stainless steel options

Reference FSD197

Circulators

Plan 54



Operating Parameters

Flow 3.8 or 15 l/min
(1 or 4 gpm)
Pressure 27.6 bar (400 psi)
Temperature 4.4 to -60°C (40 to 140°F)
Volume 95 liter (25 gallon)

Features

- Plan 54 circulators are designed to provide clean barrier fluid at a controlled flow rate, pressure and temperature
- Flow is created by a positive displacement pump and pressure is controlled by valves
- System cleanliness is maintained using one or more high quality full flow liquid filters to ensure the fluid is clean and free of contamination
- Plan 54 systems can be instrumented to support multiple seals or pumps
- A wide range of instrumentation can be selected according to local standards and adapted to suit application and customer requirements
- Cooling coil inside the reservoir is optional

Reference FSD122

Fill Cart

Reservoir refill



Operating Parameters

Pressure 103 bar (1500 psi)
Volume 76 liter (20 gallon)

Features

- Refill your supply tanks in operation without pump downtime or venting unwanted gases to atmosphere
- Capable of injecting new barrier fluid into the supply tank at pressures up to 103 bar (1500 psi)
- Rugged construction, easy-to-maneuver 76 liter (20 gallon) reservoir with hand pump mounted on a cart with pneumatic tires
- Available with color-coded quick disconnects to prevent refilling with the incorrect barrier fluid



Bearing Gard II 51
 BGM 51
 Seal Gard I and II 51
 Magnetic Separator . . . 52
 Cyclone Separator 52
 SLD 52

Accessories

Focused on the primary goals of long term reliability, safety, and minimal maintenance, accessories for mechanical seals and associated equipment help customers achieve these objectives. Cyclone separators and magnetic separators, when added to a piping plan remove entrained particulate from the coolant stream, thus protecting seals and other system components. Seal Gard flow controllers provide just the right amount of flush flow to keep seals running cool and clean.

As a valuable ancillary sealing product, labyrinth and magnetic bearing isolators installed in pump bearing frames and electric motors keep contamination away from the bearings optimizing operating conditions for greater longevity and ultimately contributing to less downtime for the complete drive train system.

Presented in this catalog is a sampling of available accessories offered by Flowserve. A collection of other supporting products such as Duraclear synthetic lubricants and barrier fluids, various throat bushings, solids excluder devices, flow management orifices, gasket materials and instrumentation complete the package necessary for well designed seal support systems. Reaching back to our heritage, we also supply an array of compression packing materials and related tools.

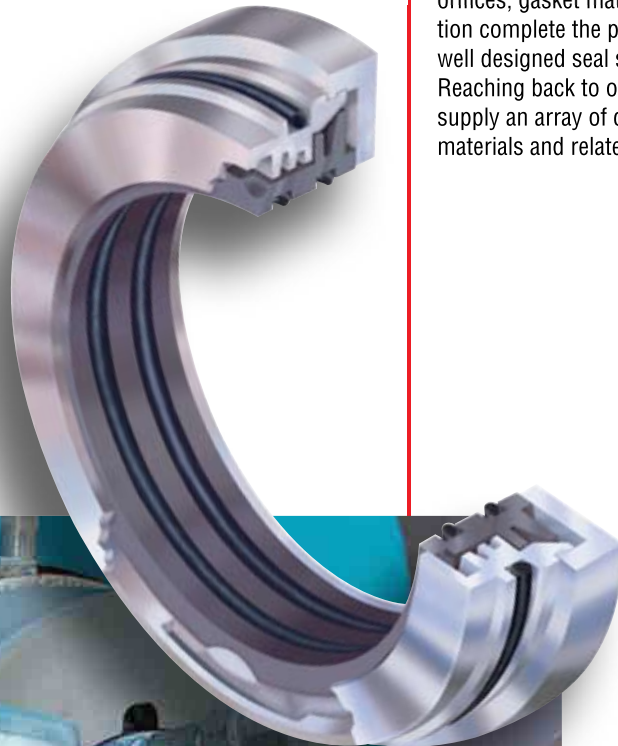

Bearing Gard II

Bearing isolators

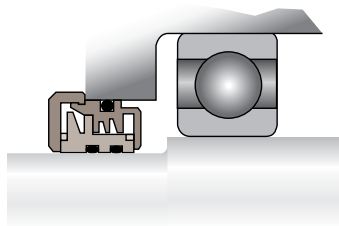

Equipment Type

- Pumps, electric motors, gearboxes, other rotating equipment

Operating Parameters

Shaft Sizes 15.9 to 254 mm
(0.625 to 10.000) inch

Features

- Installs on bearing frames used in oil & gas, chemical, mining, pulp & paper, power and general industries
- Close tolerance labyrinth design locks out moisture, grit and dust, extending bearing life and increasing the MTBR of rotating equipment
- Easy to install one piece cartridge unit. On most equipment, requires no modification
- Same day shipment of popular sizes
- Lasts the life of the equipment
- Fits existing lip seal cavities

Reference FSD124

BGM

Magnetic bearing isolators

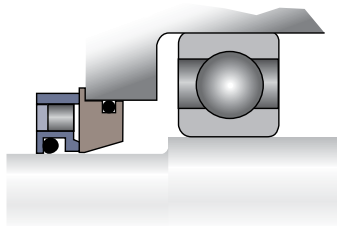

Equipment Type

- Pumps, electric motors, gearboxes, other rotating equipment

Operating Parameters

Shaft Sizes 15.9 to 152 mm
(0.625 to 6.000) inch

Features

- Installs on bearing frames used in oil & gas, chemical, mining, pulp & paper, power and general industries
- Rare earth magnets keep the seal faces closed
- Seals off the bearing housing completely from the effects of high humidity, temperature transients, heat and dust environments
- Easy to install design
- Coaxial face design provides the longest possible seal life
- Lasts up to 25 times longer than lip seals

Reference FSD149

Seal Gard I and II

Seal chamber and stuffing box protection



Equipment Type

- Pumps

Operating Parameters

Flow up to 2.6 l/min (40 gph)

Pressure up to 20.7 bar (300 psi)

up to 8.6 bar (125 psi)
140°C (300°F)

Temperature 0 to 140°C (32 to 300°F)

Connections 0.250 inch NPT

Features

- Tough, unitized construction
- Seal Gard I controls flows at low flush rates in a Plan 32 system
- Seal Gard II provides dependable flow control to support dual seals while saving water costs and reducing seal water usage
- Good for paper stock sealing systems with Flowserve split seals and split flow reducers
- The vertical, tapered acrylic flow tube resists fouling
- Easy to read pressure gauge is vibration resistant and glycerine filled
- In the upset event of lost seal water pressure, the standard check valve stops the back-up of product and prevents contamination of the water supply

Reference FSD154

Magnetic Separator

Iron particle trap



Operating Parameters

Flow	up to 15 l/min (4 gpm)
Pressure	up to 103.4 bar (1500 psi)
Temperature	up to 204°C (400°F)
Connections	0.500 inch NPT, MS-6670-DJ 0.750 inch NPT, MS-0750-DJ

Features

- Designed for Plan 23 mechanical seal injection flow and similar closed loop control lines
- Creates a magnetic field that separates and holds iron oxide particles from the process liquid
- Prevent iron particles from causing abrasion or damage

Reference FSD173

Cyclone Separator

Solid particle excluder



Operating Parameters

Flow	Clean flow output from 3.4 - 30.3 l/min (0.9 - 8 gpm)
Pressure	up to 138 bar (2000 psi) at 330°C (650°F) up to 93 bar (1350 psi) at 455°C (850°F)
Temperature	up to 455°C (850°F)
Connections	0.500 to 0.750 inch NPT or socket weld

Features

- Offered in three different sizes based on flow rate and pressure
- Cyclone separators are designed to efficiently remove sand, pipe scale and other abrasive particles from Plan 31 injection flow to mechanical seals
- Separation is accomplished by centrifugal effects generated by differential pressure across the cyclone
- When properly configured, provides up to 99% separation efficiency

Reference FSD173

SLD

Synthetic lubrication device



Operating Parameters

Process temperature	up to 80°C (175°F)
Ambient temperature	-20 to 55°C (-4 to 130°F)

Features

- Unitized system does not require air, electricity, or external water
- Ideal for single liquid seals with two hard faces and a Quench Containment Device (QCD)
- Single point lubricator allows each seal quench cavity to be satisfied independent of other equipment
- Used when no quench water is available, ideal for frequent automatic start/stop sequences and installations at remote field locations
- DS-920-OG DuraClear lubricant resists breakdown when mixed with pumpage, water or containments; optional DS-460-F lubricant is approved by USDA for incidental food contact
- Customized dispensing rate for each application; provides precise lubrication for varying operating condition

Reference FSD148

Basic design and operation

Mechanical seals provide the most effective means of sealing rotating equipment, handling process liquids and gases in modern rotating equipment such as centrifugal pumps, compressors, mixers, and reactors. The ability to effectively limit or eliminate process fluid from leaking to the environment has made the mechanical seal the default sealing device for modern industry.

While all seal designs share some common characteristics, the success of an application depends on the proper selection of the seal model, design options, materials, arrangements, and piping plans. Flowserve engineers can help provide guidance for the most appropriate seal and sealing system selection for each application.

A mechanical seal in its simplest terms creates a controlled fluid film between a rotating seal face (or rotor) and a stationary seal face (or stator). These seal faces are attached to the rotating shaft and the stationary seal chamber through adaptive hardware such as sleeves and glands. These and other seal components work together to allow the seal to operate on a very thin fluid film between the rotating and stationary seal faces. The thickness of the fluid film is engineered to minimize seal emissions and face wear while maximizing seal life and reliability.

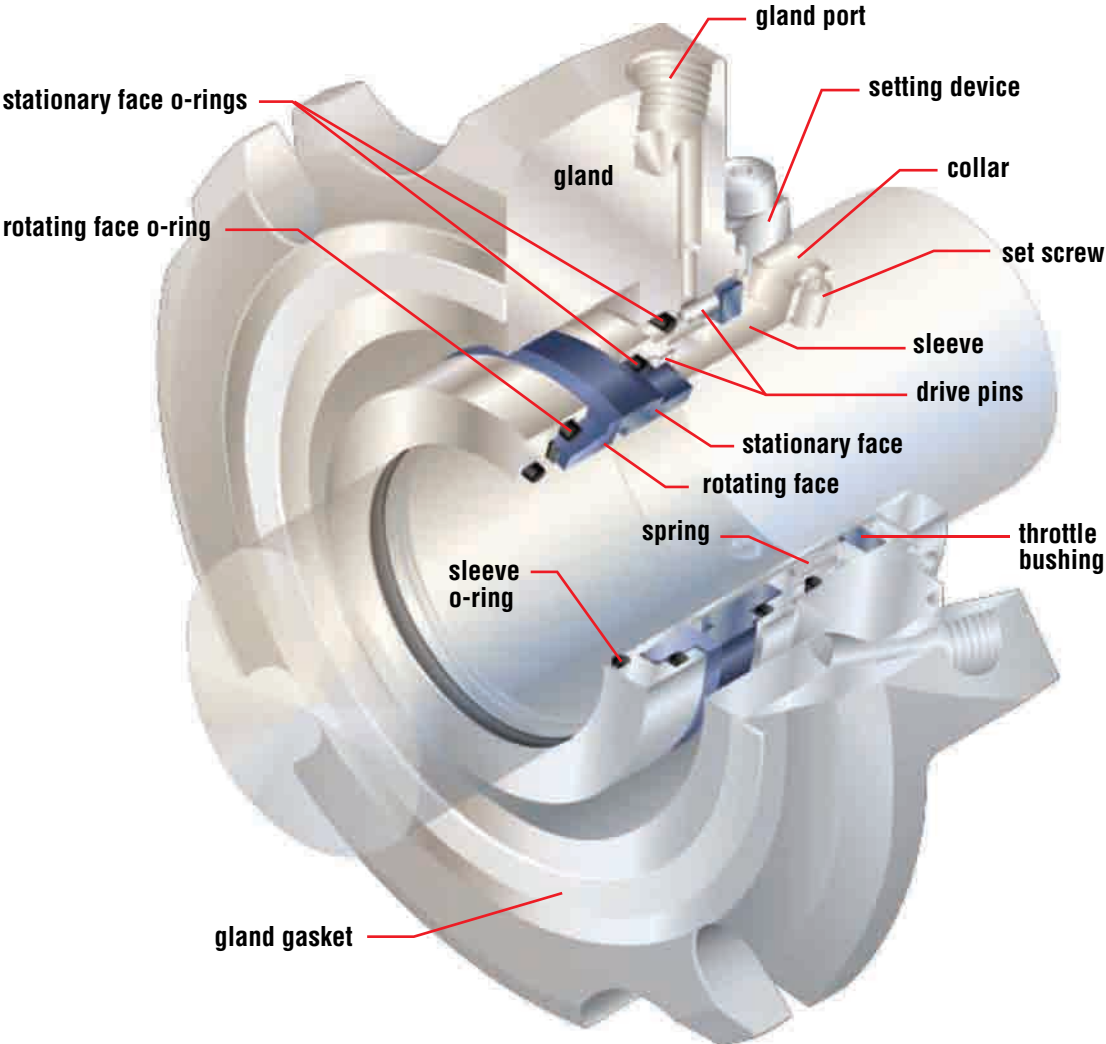

Mechanical seals can be designed to operate on liquid, gas, or mixed phase process fluids. In contacting liquid seals, the fluid film provides hydrostatic support as well as lubrication and cooling between the seal faces. The fluid film thickness is typically on the same order of magnitude as the roughness of the seal faces; approximately 0.5 micron or 20 microinches. This results in a light contact between the asperities of the seal faces allowing for a low coefficient of friction and low wear while minimizing seal emissions. Tribologically, operation in this mixed lubrication regime requires precise control of seal face topography, hydraulic loading, face deformations, and material properties. Flowserve has optimized these design factors to create the optimum seal performance.

Seal faces are also designed to operate with a gas or vapor film. This expands the ability of a mechanical seal to provide sealing into a wider range of equipment and more demanding operating window. Dry running seal faces are typically designed to operate in a noncontacting mode. Highly engineered features on the seal faces are designed to create a hydrodynamic lift which effectively separates the seal faces during operation. This results in very low power requirements and allows for operation at higher speeds and pressures.

Magnified approximately 2000 times, these three dimensional images illustrate surface roughness on silicon carbide seal faces. The grooves on the lower image are the result of light asperity contact with a carbon graphite mating face.

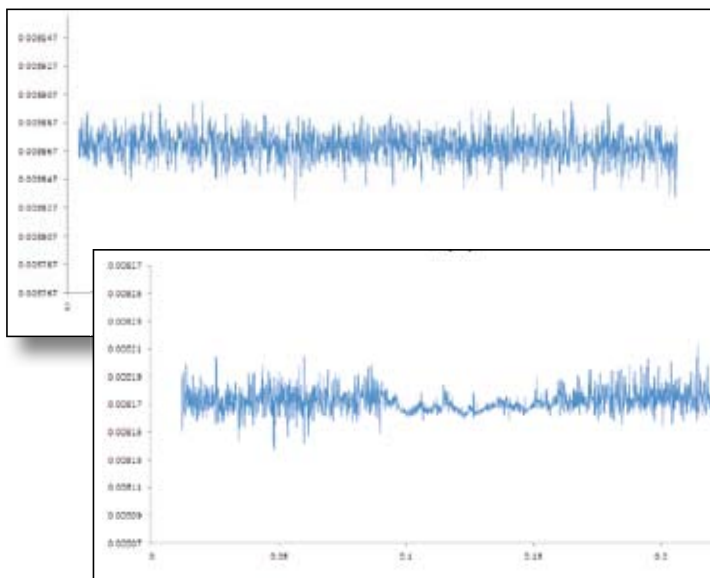
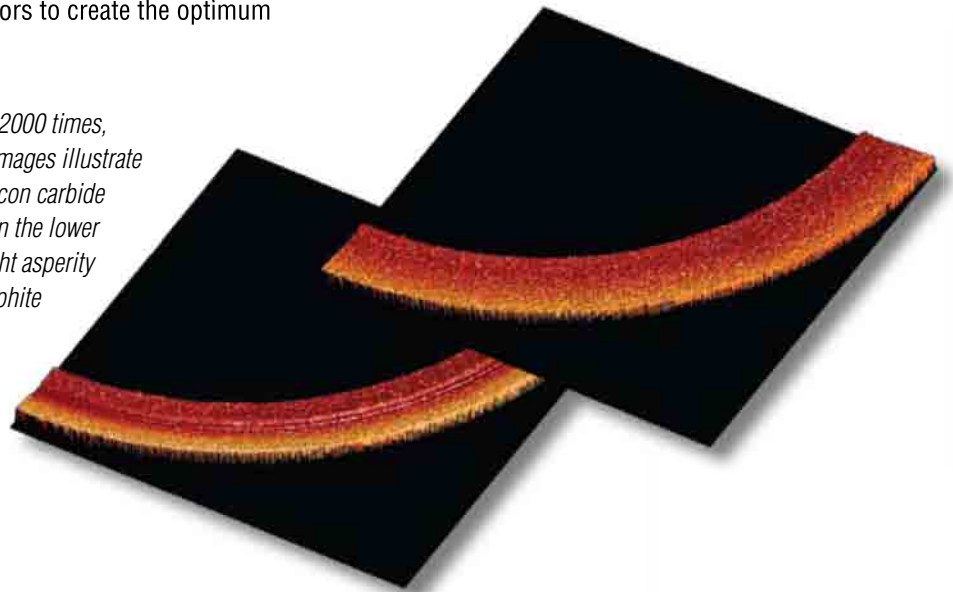

High resolution, cross sectional trace of seal face roughness. The top trace is a new face while the bottom trace illustrates the results of light asperity contact.

Precision face topography

Advanced design and manufacturing capabilities have further expanded the ability of mechanical seals to operate in more demanding environments than ever before. The control of the seal face topography and innovative design of microfeatures have redefined the way mechanical seals operate. The sealing interface is no longer restricted to only flat faces. Face features can be designed to enhance the fluid film, create lift, reduce friction, minimize emissions, and reduce wear. These features can only be created with sophisticated manufacturing techniques which are capable of providing the accuracy and precision required for these microfeatures. Flowserve has pioneered the use of these techniques in mechanical seal design and manufacturing.

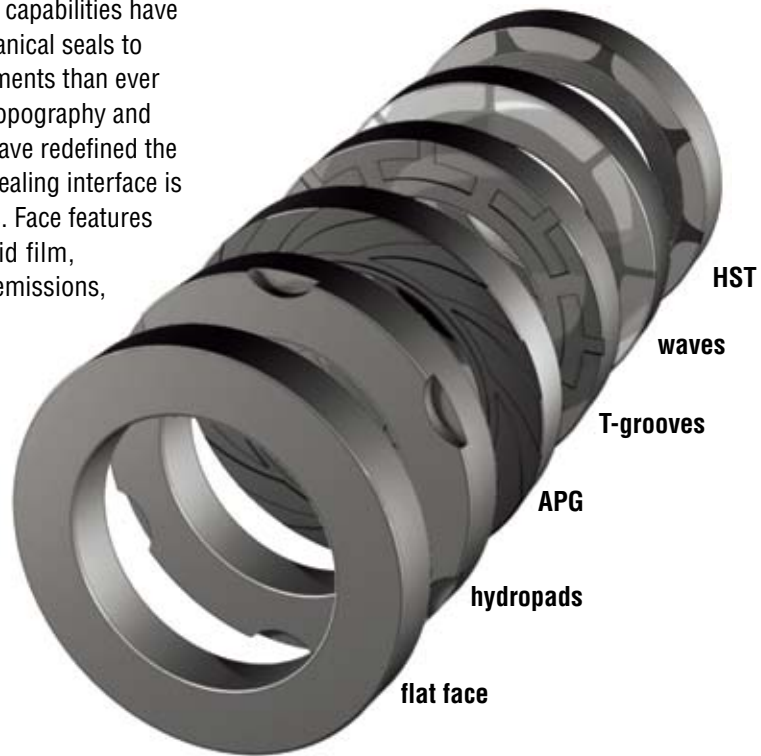

Design and modeling capabilities

Flowserve has developed some of the most advanced seal modeling and design capabilities in the world. Analytical techniques including finite element analysis (FEA) and specialized multi-physics models are specifically tailored for the unique characteristics of mechanical seals. The development of new microfeatures and face topography designs have only been possible due to advanced seal modeling capabilities. Seal models are continuously verified and refined through active research and development programs. Better modeling accuracy in the office establishes safer, more reliable mechanical seals in the field.

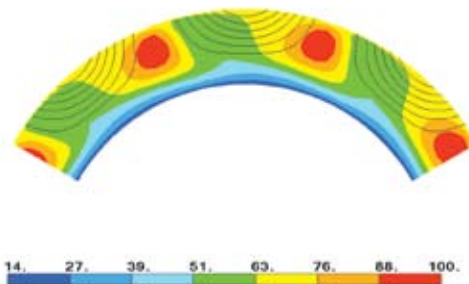
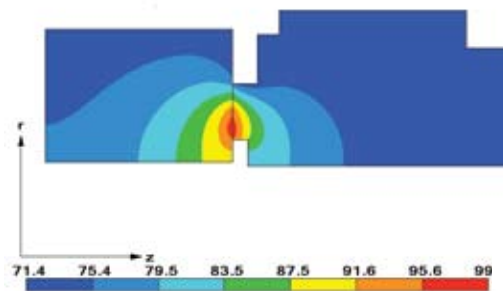

Design options

Mechanical seals are available in a wide range of designs and capabilities. This is necessary to provide solutions for the similarly wide range of pump and equipment designs, process conditions, and operating requirements demanded by industry.

The selection of the appropriate seal design, design features, seal arrangement and piping plan is critical to achieving the seal performance required by the end user. Seal designs can be categorized by a number of different design features.

Seal type

Seals are commonly categorized as “pusher seal” and “bellows seal” based on the type of mechanical loading used. A pusher seal consists of two seal faces where the flexible seal face utilizes a dynamic gasket to allow for axial motion and is loaded by mechanical springs. This is the most common seal design. Pusher seals can be designed for application conditions ranging from simple design for low duties to highly engineered complex designs for very high pressures and speeds.

A bellows seal utilizes a flexible bellows element to allow for axial motion. The bellows element itself is also commonly used to provide mechanical loading for the seal faces. One of the most common bellows seal designs uses an edge welded metal bellows. These are constructed from corrosion resistant alloys which allow their use in harsh chemical environments. Special designs with flexible graphite gasketing are designed to operate at extreme temperatures. By eliminating the dynamic gasket, bellows seals can be more tolerant of solids or process contamination. Elastomeric bellows designs are also commonly used in lower duty services.

Cartridge and component seals

Mechanical seals have historically been offered as both component seals and cartridge seals. A component seal consists of basic seal parts which must be installed into the pump as individual components. This requires significant skills and care to ensure proper installation. A cartridge seal is packaged so that all components are preassembled and can be installed into the pump as a complete assembly. This ensures that all the components are correctly installed and not damaged during installation. Most mechanical seals supplied to industrial users are provided as cartridge seals.

Component pusher seal

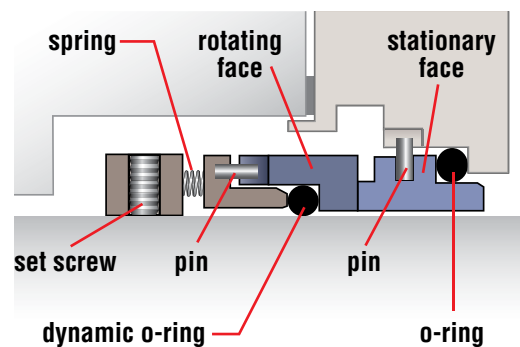

Component metal bellows seal

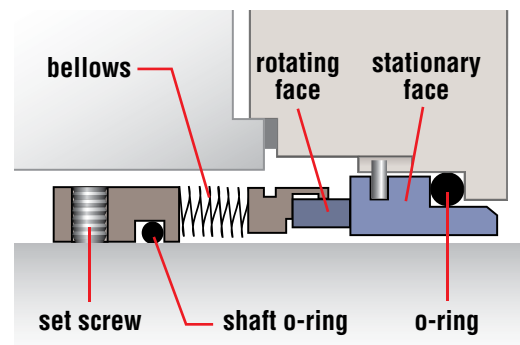

Cartridge pusher seal

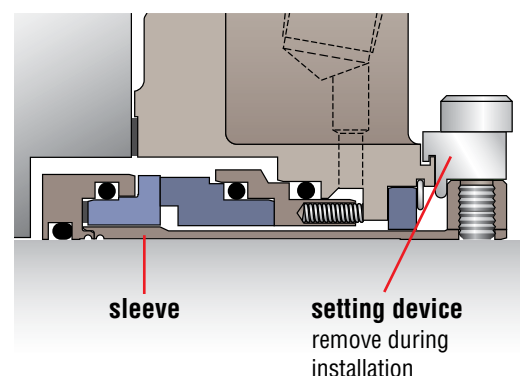

Rotating vs stationary flexible element

The flexible element (springs or bellows) can be designed so they rotate with the seal sleeve or are stationary with the seal gland. Rotating flexible elements are the most common design and provide for small radial cross sections and self-cleaning performance. Stationary flexible elements can tolerate higher equipment misalignments and can operate at higher speeds. Most sealing applications can be satisfactorily sealed with either design.

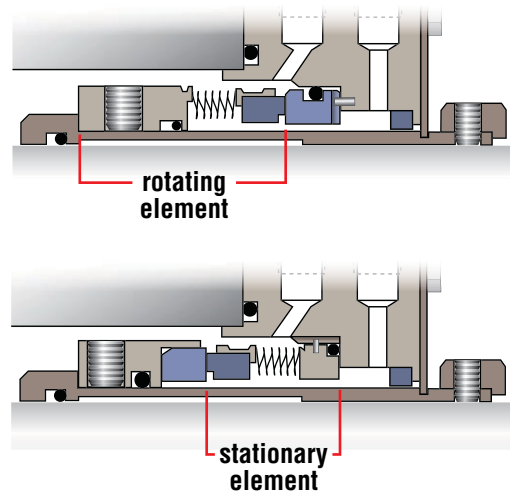

Single and dual seals

Most mechanical seal installations have one set of seal faces in the assembly. There are however applications where it is beneficial to have multiple seals to provide reduced emissions or sealing redundancy. These options are described as seal arrangements.

Arrangement 1 seals are single seals which contain one set of seal faces. This provides for a simple installation although all leakage goes to the atmospheric side of the seal. Arrangement 2 seals have two sets of seal faces where the cavity between the two seals is maintained at a lower pressure than the seal chamber pressure.

Any leakage past the primary seal is captured in this cavity which minimizes process exposure to the environment. This dual seal arrangement also provides sealing redundancy if one seal fails. Arrangement 3 seals have two sets of seal faces where the cavity between the two seals is maintained at a pressure greater than the seal chamber pressure. This has the benefit of eliminating any process leakage to the environment and making the seal less dependent on process conditions. All seal arrangements are commonly used in industry.

Arrangement 1 - Single seal

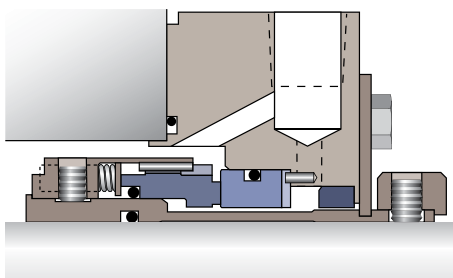

Arrangement 2 and 3 - Dual seal

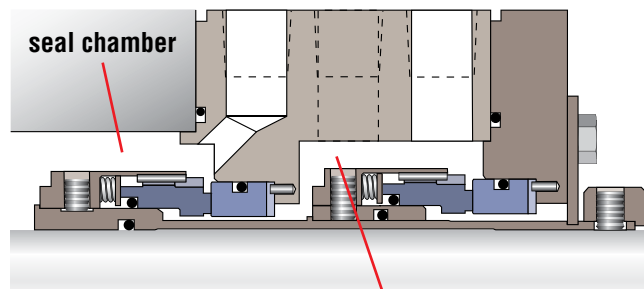

cavity between seals

Arrangement 2 - pressure is lower than seal chamber

Arrangement 3 - pressure is higher than seal chamber

Operating window

Seals are designed to operate successfully in a range of operating conditions. No one seal design is capable of operating in every application. For this reason, each seal model has an operating window which defines the applications where the seal is suitable. In some cases these limits represent mechanical limitations and in other cases material limitations. This catalog uses the following parameters to define the operating window for a specific seal model: Pressure, Temperature, Speed, and Size.

While these parameters capture the significant design factors for a seal, the actual application conditions may dictate a different operating window. Fluid properties can change dramatically and will affect the operating

window for the seal. For example, lubricating oil at 93°C (200°F) behaves quite differently than water at the same temperature. The selection of materials for an individual component, especially elastomers, may also restrict the operating window. Finally, the combination of all of these factors will dictate the suitability of the seal for an application. The operating window for any mechanical seal will serve as an initial screening for seal selection however true suitability can only be determined by a more thorough engineering review.

Seal materials

Mechanical seals contain multiple components serving very different functions and require materials ranging from elastomers to ceramics. While these materials have very different properties, they must all work together to provide satisfactory seal performance.

Seal faces

The seal faces in a mechanical seal are arguably the most critical components and require the greatest care in material selection. Historically, a wide variety of materials have been used from metals and overlays to ceramics and carbons. Advances in seal face materials have greatly enhanced the performance of modern seals. The most common seal face materials are listed below.

Reaction Bonded Silicon Carbide	General duty hard face material, excellent physical properties, cannot be used in caustics and/or aggressive acids
Sintered Silicon Carbide	General and chemical duty hard face material, excellent physical properties, used in aggressive chemical applications
Nickel Bound Tungsten Carbide	General duty hard face material, excellent physical properties, impact resistant, limited use in aggressive chemicals
Alumina Oxide	Chemical duty hard face material, excellent chemical resistance, limited to low duty services
Resin Impregnated Carbon	General duty soft face material, good chemical resistance, good frictional properties
Metallized Carbon	Antimony metal filled carbon, high duty soft face material, limited chemical resistance, good physical properties, blister resistant

Elastomers and secondary seals

The seal face pair in a mechanical seal is called the primary seal and all other sealing points are referred to as secondary seals. Secondary seals are used throughout mechanical seals. These are most commonly in the form of elastomeric O-rings although spring energized gaskets, flat gaskets, or formed gaskets are also used. Secondary seals, especially O-rings, are available in all common elastomeric materials such as FKM, FFKM, EPDM, and NBR. PTFE based gaskets and flexible graphite gaskets are used where their unique properties are required. The basic seal design will dictate which materials are available for each seal model.

Metallic components

A significant number of seal components are manufactured from metallic materials. Metallic components are selected to provide both the physical properties and corrosion resistance required by the application. The default material for most seal components is austenitic stainless steel (Alloy 316) although other higher alloys metals are commonly available such as Alloy C-276, Alloy 400, and Alloy 20. More exotic alloys such as zirconium, titanium and duplex are also available in some seal models. Metal bellows seals have special requirements and are commonly provided in Alloy C-276, Alloy 718, Alloy 316, and Alloy 400. The basic seal design and operating environment will determine which seal alloy should be used.

Industry standards

There are several internationally recognized standards organizations which publish standards for mechanical seals and their related equipment. These include ISO, API, ASME, and HI. Flowserve engineers are key technical contributors to these organizations and help define the future of the sealing industry. Flowserve can provide seals and systems in compliance with any of these sealing standards or specifications.



Mechanical Seal Piping Plans

Flowserve recognizes that one of the most effective ways to achieve long, uninterrupted mechanical seal life is to create a healthy environment around the seal faces. Piping plans help keep mechanical seals running cool and clean, promote safe handling of dangerous fluids, and extend the operational availability of rotating equipment. The following pages provide a concise summary of the most essential piping plans used successfully in today's process plants.

Each plan shows all the standard and optional components referenced in API 682 / ISO 21049 and recommended by Flowserve. Consult your local Flowserve sales engineer to identify the right solution that satisfies your application requirements.



Good Piping Practices

Pipe size should be selected in relation to the seal size and cooling requirements. A minimum of 0.500 NPS should be used in general services and at least 0.750 NPS for API or heavy duty seals. Pipe runs should be sloped for proper venting and draining, making sure the entire loop (including the seal gland) does not include vapor traps. Vertical pumps require special attention to achieve proper venting.

Piping should be as short as possible to avoid high pipe friction losses, especially with higher viscosity barrier liquids such as oils. Sharp radius bends and gate valves in the loop must be avoided. The top of the seal gland should contain the flow outlet, while the inlet should be at the bottom or lower than the outlet.

Reference FTA160

Single Seals - Plan 23 shown

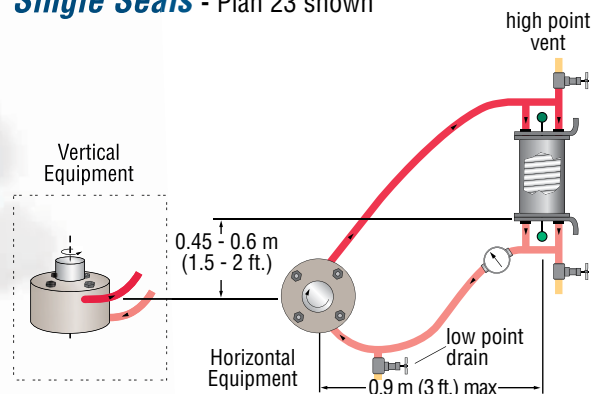

Dual Seals - Plan 53A shown

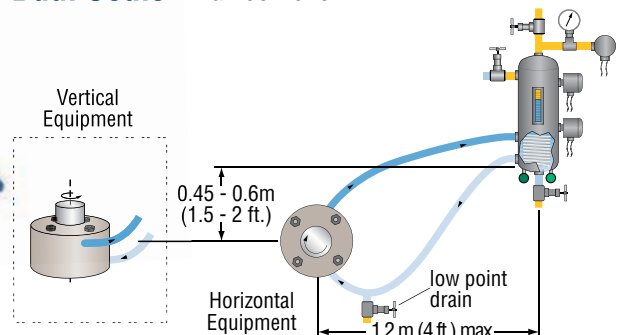

Plan 11

Seal flush from pump discharge through orifice.

Default single seal flush plan.

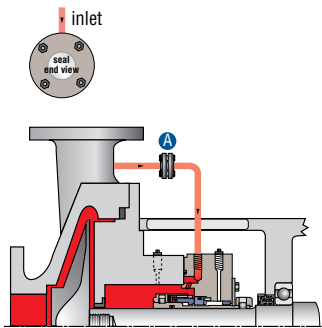

A - orifice

Plan 14

Seal flush from pump discharge and recirculation to pump suction with orifices.

Combination of Plan 11 and Plan 13.

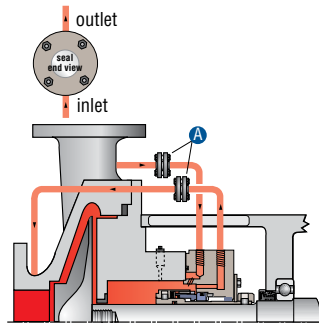

A - orifice

Plan 23

Seal flush from internal pumping device through cooler.

Standard flush plan in hot water services.

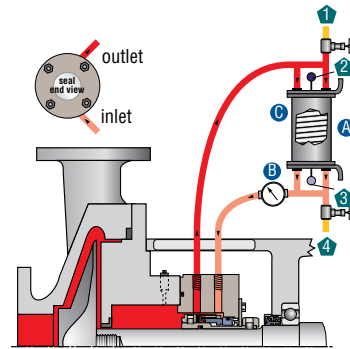

A - cooling coils
 B - temperature indicator
 C - cooler
 1 - vents, normally closed
 2 - cooling out
 3 - cooling in
 4 - drain, normally closed

Plan 13

Recirculation from seal chamber to pump suction through orifice.

Standard flush plan on vertical pumps.

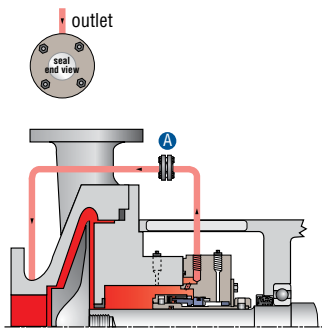

A - orifice

Plan 21

Seal flush from pump discharge through orifice and cooler.

Cooler added to Plan 11 flush increases heat removal.

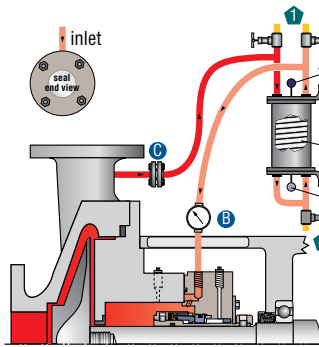

A - cooling coils
 B - temperature indicator
 C - orifice
 1 - vents, normally closed
 2 - cooling out
 3 - cooling in
 4 - drain, normally closed

Plan 31

Seal flush from pump discharge through cyclone separator.

Centrifuged solids are returned to pump suction.

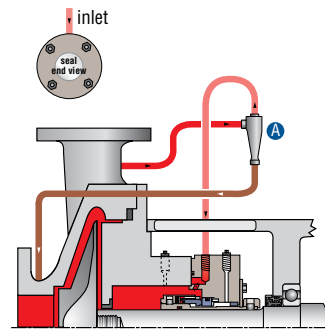

A - cyclone separator

Plan 32

Seal flush from an external clean source.

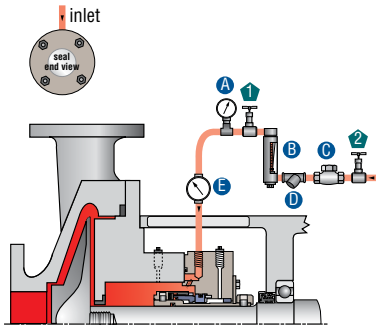

- A - pressure indicator
- B - flow indicator (optional)
- C - check valve
- D - strainer
- E - temperature indicator (optional)
- 1 - flow control valve
- 2 - from clean source, normally open

Plan 52

Unpressurized buffer fluid circulation through reservoir.

Fluid is circulated by a pumping ring in the dual seal assembly.

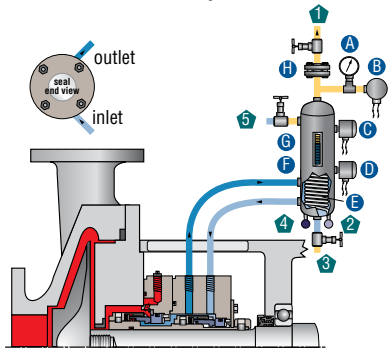

- A - pressure indicator
- B - pressure switch (high)
- C - level switch (high)
- D - level switch (low)
- E - cooling coils
- F - reservoir
- G - level indicator
- H - orifice
- 1 - vent, normally open
- 2 - cooling in
- 3 - drain, normally closed
- 4 - cooling out
- 5 - liquid fill, normally closed

Plan 53A

Pressurized barrier fluid circulation through reservoir.

Fluid is circulated by a pumping ring in the dual seal assembly.

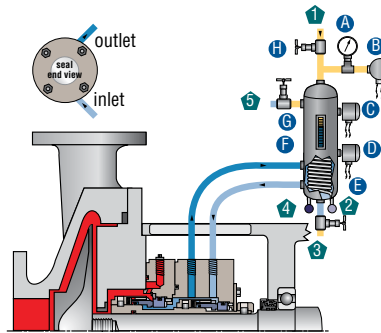

- A - pressure indicator
- B - pressure switch (low)
- C - level switch (high)
- D - level switch (low)
- E - cooling coils
- F - reservoir
- G - level indicator
- H - vent, normally open
- 1 - pressure source, normally open
- 2 - cooling in
- 3 - drain, normally closed
- 4 - cooling out
- 5 - liquid fill, normally closed

Plan 53B

Pressurized barrier fluid circulation with bladder accumulator.

Fluid is circulated by a pumping ring in the dual seal assembly.

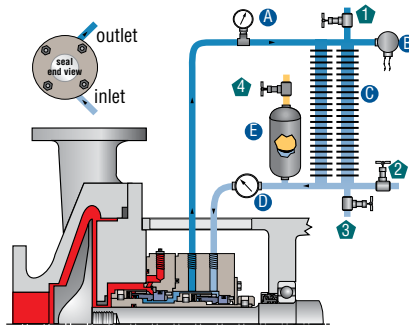

- A - pressure indicator
- B - pressure switch (low)
- C - finned pipe (alternative reservoir)
- D - temperature indicator
- E - bladder accumulator
- H - vent, normally closed
- 1 - vent, normally closed
- 2 - liquid fill, normally closed
- 3 - drain, normally closed
- 4 - pressure source, normally closed

Plan 53C

Pressurized barrier fluid circulation with piston accumulator.

Fluid is circulated by a pumping ring in the dual seal assembly.

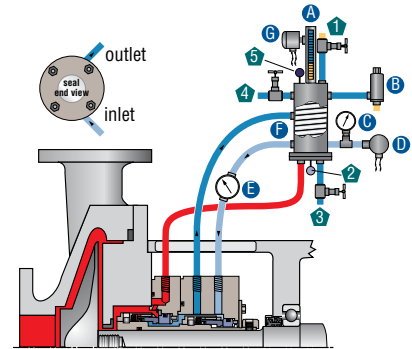

- A - level indicator
- B - pressure relief valve
- C - pressure indicator
- D - pressure switch (low)
- E - temperature indicator
- F - cooling coils
- G - level switch (low)
- H - vent, normally closed
- 1 - vent, normally closed
- 2 - cooling in
- 3 - drain, normally closed
- 4 - liquid fill, normally closed
- 5 - cooling out

Plan 54

Pressurized barrier fluid circulation by external system.

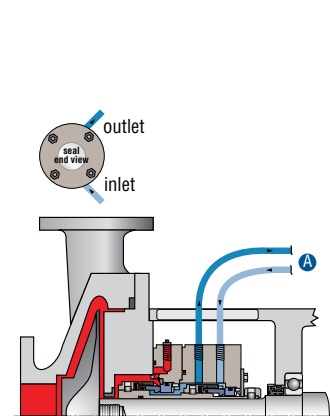

- A - from / to external circulating system

Plan 62

External quench on atmospheric side of seal.

Quench fluids typically steam, nitrogen, or water.

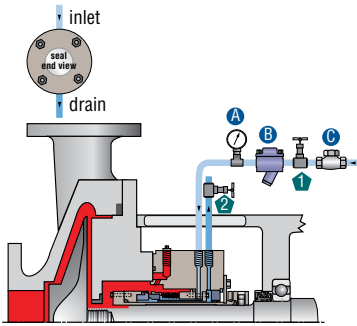

- A - pressure indicator (optional)
- B - steam trap (steam quench)
- C - check valve
- 1 - quench, normally open
- 2 - drain, normally open

Plan 65

External drain with leakage detection on atmospheric side of seal.

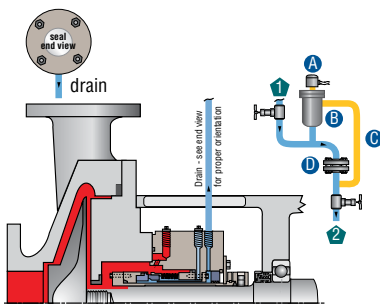

- A - level switch (high)
- B - overflow chamber
- C - bypass line
- D - orifice
- 1 - block valve, normally open
- 2 - drain, normally open

Plan 72

Unpressurized buffer gas control system.

Containment seal support typically with nitrogen buffer gas.

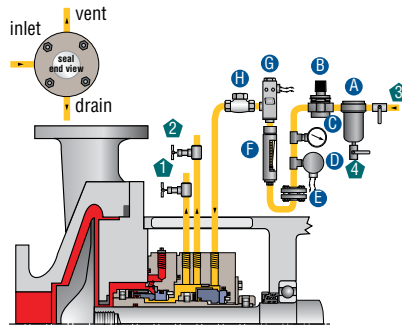

- A - coalescing filter
- B - regulator
- C - pressure indicator
- D - pressure switch (low)
- E - orifice
- F - flow indicator
- G - flow switch (high)
- H - check valve
- 1 - drain
- 2 - vent
- 3 - gas inlet, normally open
- 4 - filter drain, normally closed

Plan 74

Pressurized barrier gas control system.

Gas seal support typically with nitrogen barrier gas.

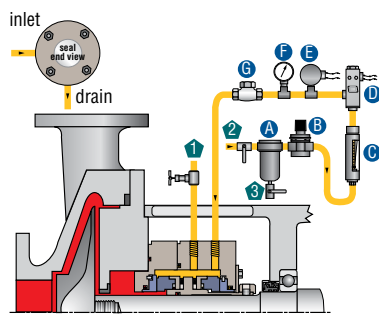

- A - coalescing filter
- B - regulator
- C - flow indicator
- D - flow switch (high)
- E - pressure switch (low)
- F - pressure indicator
- G - check valve
- 1 - upset drain, normally closed
- 2 - gas inlet, normally open
- 3 - filter drain, normally closed

Plan 75

Drain from containment seal cavity to collector and vapor recovery.

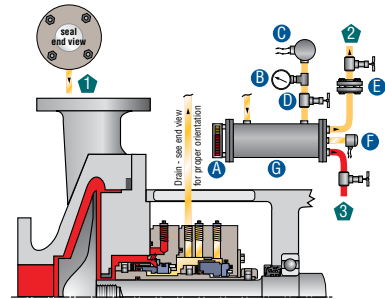

- A - level indicator
- B - pressure indicator
- C - pressure switch (high)
- D - isolation valve
- E - orifice
- F - level switch (high)
- G - reservoir located below seal drain port
- 1 - drain
- 2 - vent, normally open
- 3 - drain, normally closed

Plan 76

Vent from containment seal cavity to vapor recovery.

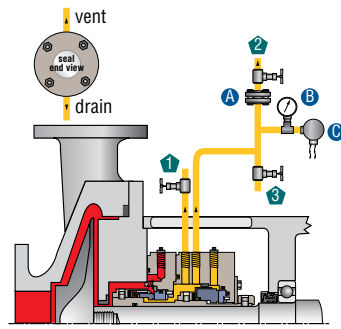

- A - orifice
- B - pressure indicator
- C - pressure switch (high)
- 1 - drain, normally closed
- 2 - vent, normally open
- 3 - drain, normally closed

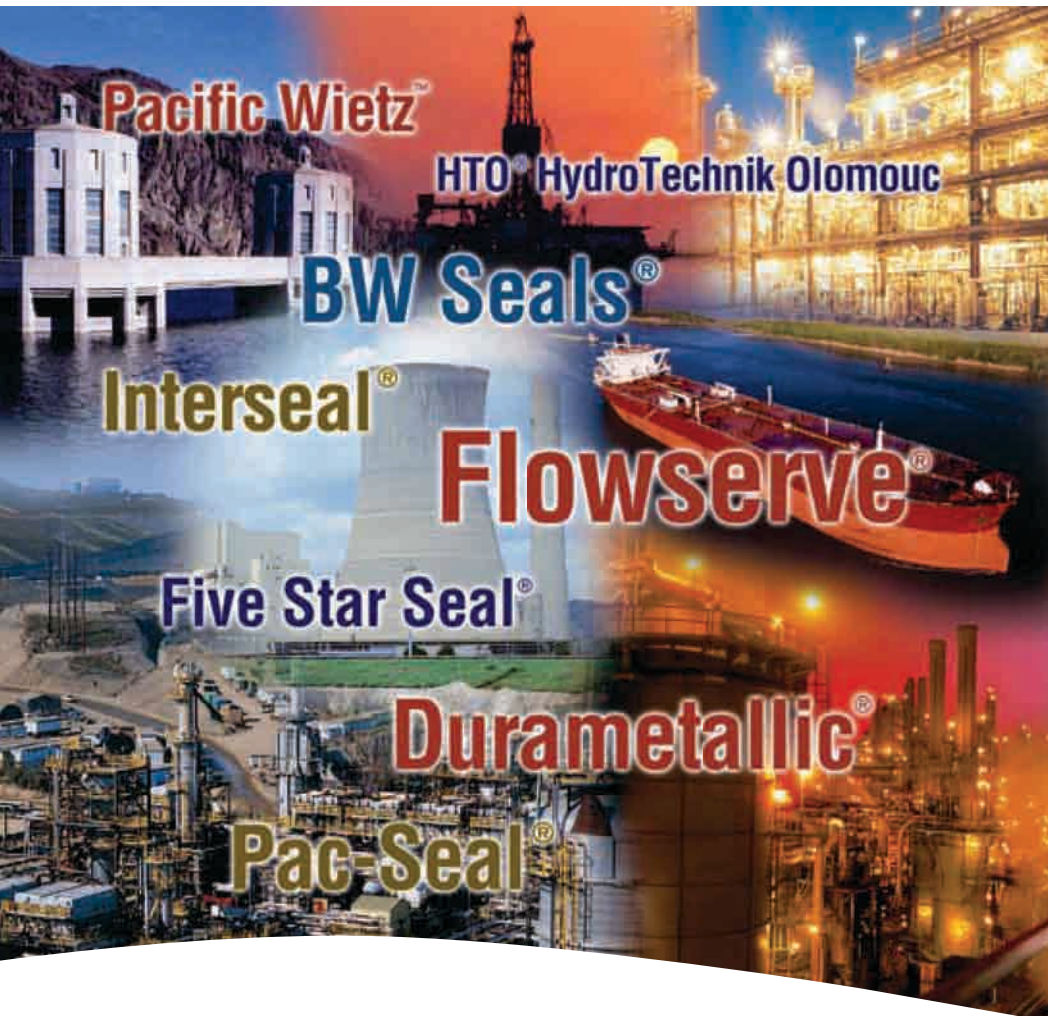

USA and Canada

Kalamazoo, Michigan USA
Telephone: 1 269 381 2650
Telefax: 1 269 382 8726

Europe, Middle East, Africa

Roosendaal, The Netherlands
Telephone: 31 165 581400
Telefax: 31 165 554590

Asia Pacific

Singapore
Telephone: 65 6544 6800
Telefax: 65 6214 0541

Latin America

Mexico City
Telephone: 52 55 5567 7170
Telefax: 52 55 5567 4224

FSD101eng REV 06-12 Printed in USA.

To find your local Flowserve representative
and find out more about Flowserve Corporation,
visit www.flowserve.com

Flowserve Corporation has established industry leadership in the design and manufacture of its products. When properly selected, this Flowserve product is designed to perform its intended function safely during its useful life. However, the purchaser or user of Flowserve products should be aware that Flowserve products might be used in numerous applications under a wide variety of industrial service conditions. Although Flowserve can provide general guidelines, it cannot provide specific data and warnings for all possible applications. The purchaser/user must therefore assume the ultimate responsibility for the proper sizing and selection, installation, operation, and maintenance of Flowserve products. The purchaser/user should read and understand the Installation Instructions included with the product, and train its employees and contractors in the safe use of Flowserve products in connection with the specific application.

While the information and specifications contained in this literature are believed to be accurate, they are supplied for informative purposes only and should not be considered certified or as a guarantee of satisfactory results by reliance thereon. Nothing contained herein is to be construed as a warranty or guarantee, express or implied, regarding any matter with respect to this product. Because Flowserve is continually improving and upgrading its product design, the specifications, dimensions and information contained herein are subject to change without notice. Should any question arise concerning these provisions, the purchaser/user should contact Flowserve Corporation at any one of its worldwide operations or offices.

© 2012 Flowserve Corporation